

**AGENDA  
IRVINE RANCH WATER DISTRICT  
BOARD OF DIRECTORS  
REGULAR MEETING**

October 26, 2020

*Due to COVID-19, this meeting will be conducted as a teleconference pursuant to the provisions of the Governor's Executive Orders N-25-20 and N-29-20, which suspend certain requirements of the Ralph M. Brown Act. Members of the public may not attend this meeting in person.*

Participation by members of the Board of Directors will be from remote locations. Public access and participation will only be available telephonically/electronically.

To virtually attend the meeting and to be able to view any presentations or additional materials provided at the meeting, please join online via Webex using the link and information below:

Via Web:

<https://irwd.my.webex.com/irwd.my/j.php?MTID=m8e95f315c1b82787e690c9b10e01ca89>

Meeting Number (Access Code): 126 221 6274

Meeting Password: UsHVxx6Y7j6 (87489969 from phones and video systems)

After joining the meeting, in order to ensure all persons can participate and observe the meeting, please select the "Call in" option and use a telephone to access the audio for the meeting by using the call-in information and attendee identification number provided.

*As courtesy to the other participants, please mute your phone when you are not speaking.*

**PLEASE NOTE:** Participants joining the meeting will be placed into the WebEx lobby when the Board enters closed session. Participants who remain in the "lobby" will automatically be returned to the open session of the Board once the closed session has concluded. Participants who join the meeting while the Board is in closed session will receive a notice that the meeting has been locked. They will be able to join the meeting once the closed session has concluded.

**CALL TO ORDER**      5:00 p.m.

**ROLL CALL**              Directors Reinhart, LaMar, Swan, and Withers, and President Matheis

**PUBLIC COMMENT NOTICE**

If you wish to address the Board of Directors on any item, please submit a request to speak via the "chat" feature available when joining the meeting virtually. Remarks are limited to three minutes per speaker on each subject. You may also submit a public comment in advance of the meeting by emailing [comments@irwd.com](mailto:comments@irwd.com) before 12:00 p.m. on Monday, October 26, 2020.

**ALL VOTES SHALL BE TAKEN BY A ROLL CALL VOTE.**

---

**COMMUNICATIONS TO THE BOARD**

---

1. A. Written:

B. Oral:

2. ITEMS RECEIVED TOO LATE TO BE AGENDIZED

Recommendation: Determine the need to discuss and/or take immediate action on item(s).

---

**PRESENTATION**

---

3. MICHELSON WATER RECYCLING PLANT BIOSOLIDS AND ENERGY RECOVERY FACILITIES OPERATIONS UPDATE

Staff will provide an update on the startup and commissioning activities for the Class A biosolids treatment systems of this project.

---

**CONSENT CALENDAR**

**Next Resolution No. 2020-19**

**Items 4-7**

---

4. BOARD MEETING MINUTES

Recommendation: That the minutes of the October 12, 2020 Regular Board meeting be approved as presented.

5. RATIFY/APPROVE BOARD OF DIRECTORS' ATTENDANCE AT MEETINGS AND EVENTS

Recommendation: That the Board ratify/approve the meetings and events for Steven LaMar, Mary Aileen Matheis, Peer Swan, and John Withers, as described.

6. IRWD STRATEGIC MEASURES

Recommendation Receive and file.

7. SEPTEMBER 2020 TREASURY REPORT

Recommendation: That the Board receive and file the Treasurer's Investment Summary Report, the Summary of Fixed and Variable Rate Debt, and Disclosure Report of Reimbursements to Board members and staff, approve the September 2020 Summary of Payroll ACH payments in the total amount of \$2,125,589, and approve the September 2020 accounts payable Disbursement Summary of warrants 411399 through 412074, Workers' Compensation distributions, wire transfers, payroll withholding distributions and voided checks in the total amount of \$16,965,031.

---

**ACTION CALENDAR**

---

8. INTRODUCTION OF PRETREATMENT ORDINANCE FOR FACILITIES TRIBUTARY TO SOUTH ORANGE COUNTY WASTEWATER AUTHORITY

Recommendation: That the Board approve the introduction of an ordinance amending pretreatment regulations for discharges to sewerage facilities tributary to the South Orange County Wastewater Authority and repealing Ordinance No. 2015-1, waive the reading of the ordinance in its entirety, set a second reading on the ordinance for the Board's regular meeting on November 23, 2020, direct the General Counsel to prepare a summary of the ordinance for publication, and order publication of the required public notices.

9. MICHELSON WATER RECYCLING PLANT PRIMARY CLARIFIERS 1-5 COVERS REPLACEMENT CONSTRUCTION AWARD

Recommendation: That the Board authorize the General Manager to execute a construction contract with GSE Construction Company, Inc. in the amount of \$840,300 for the Michelson Water Recycling Plant Primary Clarifiers 1-5 Covers Replacement, Project 11599.

---

**OTHER BUSINESS**

---

Pursuant to Government Code Section 54954.2, members of the Board of Directors or staff may ask questions for clarification, make brief announcements, and make brief reports on his/her own activities. The Board or a Board member may provide a reference to staff or other resources for factual information, request staff to report back at a subsequent meeting concerning any matter, or direct staff to place a matter of business on a future agenda. Such matters may be brought up under the General Manager's Report or Directors' Comments.

10. General Manager's Report

11. Directors' Comments

12. Receive oral update(s) from District liaison(s) regarding communities within IRWD's service area and provide information on relevant community events.

13. Adjourn.

\*\*\*\*\*

Availability of agenda materials: Agenda exhibits and other writings that are disclosable public records distributed to all or a majority of the members of the above-named Board in connection with a matter subject to discussion or consideration at an open meeting of the Board are available for public inspection in the District's office, 15600 Sand Canyon Avenue, Irvine, California ("District Office"). If such writings are distributed to members of the Board less than 72 hours prior to the meeting, they will be available from the District Secretary of the District Office at the same time as they are distributed to Board Members, except that if such writings are distributed one hour prior to, or during, the meeting, they will be available electronically via the Webex meeting noted. Upon request, the District will provide for written agenda materials in appropriate alternative formats, and reasonable disability-related modification or accommodation to enable individuals with disabilities to participate in and provide comments at public meetings. Please submit a request, including your name, phone number and/or email address, and a description of the modification, accommodation, or alternative format requested at least two days before the meeting. Requests should be emailed to [comments@irwd.com](mailto:comments@irwd.com). Requests made by mail must be received at least two days before the meeting. Requests will be granted whenever possible and resolved in favor of accessibility.



October 26, 2020

Prepared by: S. Toland / R. Mori / J. Zepeda

Submitted by: K. Burton / W. Chambers

Approved by: Paul A. Cook



## PRESENTATION

### MICHELSON WATER RECYCLING PLANT BIOSOLIDS AND ENERGY RECOVERY FACILITIES OPERATIONS UPDATE

#### SUMMARY:

Construction of the Michelson Water Recycling Plant (MWRP) Biosolids and Energy Recovery Facilities is complete, and startup and commissioning activities are nearing completion. As the project transitions from the construction phase to the operational phase, staff is now operating portions of the facilities while continuing to support the contractor with remaining startup and commissioning activities. At the Board meeting, staff will present an overview of the commissioning activities along with an update on facility operations.

#### BACKGROUND:

Construction of the Biosolids project was awarded to Filanc/Balfour-Beatty Joint Venture in March 2013 in the amount of \$163,465,940. The Biosolids project will provide biosolids digestion, dewatering, energy production, and on-site sludge drying. The project includes excavation for subsurface structures, installation of foundation piles, three egg-shaped methane digesters, a state-of-the-art odor control system, a biogas conditioning system and power generation using micro-turbines, a fats, oil and grease receiving station, and new utility services.

In June 2020, both primary and waste activated sludge were introduced into the newly constructed treatment facilities for the first time. Since then, staff has been operating the thickening centrifuges and digesters, focusing on the sludge maturation process in the digesters. Initially, staff introduced sludge to the digesters for a few hours per day; as the sludge continued to mature, staff has increased the sludge feed to nearly 24 hours per day. The digesters are now in full operation, and biogas is being produced. Staff is delivering the biogas to the flare until the microturbines are brought online later this year. In the coming months, staff and the contractor will complete commissioning activities for the dewatering centrifuges, microturbines, and the dryer.

At the Board meeting, staff will present an overview of the commissioning activities completed to date, the schedule for completion of the remaining commissioning activities, and an update on operation of the facilities. A draft of this presentation is provided as Exhibit "A".

#### FISCAL IMPACTS:

Not applicable.

#### ENVIRONMENTAL COMPLIANCE:

Not applicable.

Presentation: Michelson Water Recycling Plant Biosolids and Energy Recovery Facilities  
Operations Update  
October 26, 2020  
Page 2

COMMITTEE STATUS:

This item was not reviewed by a Committee.

RECOMMENDATION:

RECEIVE AND FILE.

LIST OF EXHIBITS:

Exhibit "A" – MWRP Biosolids and Energy Recovery Facilities Operations Update Presentation

# Michelson Water Recycling Plant Biosolids and Energy Recovery Facilities

## Operations Update

Board of Directors Meeting  
October 26, 2020



1

## Agenda

*Presentation Purpose: To update the Board on the transition from construction / start-up to operations.*

- Startup and Commissioning Overview
- Operations Update
- Project Costs
- Schedule
- Questions



Irvine Ranch Water District

2

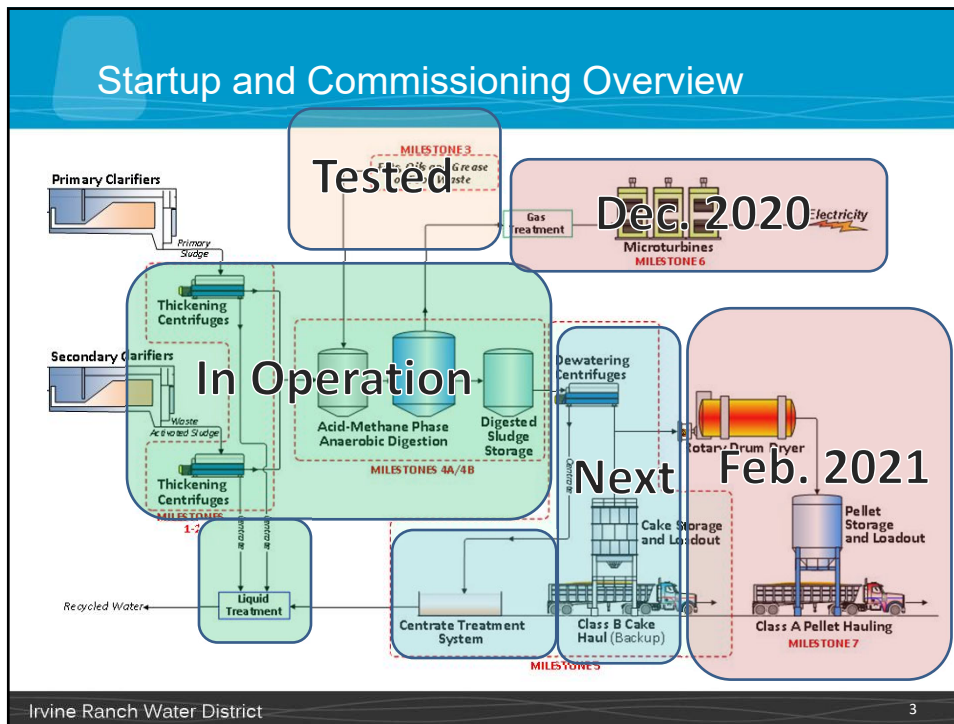

3

## Terms & Teamwork

- Summary of Key Terms: *The 3 D's*
  - Digestion: Microbial breakdown of volatile solids to biogas (methane)
  - Dewatering: Process to increase solids concentration from 2% to 25%
  - Dryer: Further increase from 25% cake to 92% solid content (pellets)
- Startup & Commissioning – a Team Effort
  - Complex project supported by multiple departments

*Biosolids Facilities Control Room*

Irvine Ranch Water District 4

4

## Strong Staff Expertise

- Hired experienced staff, phased-in over three years
- Many staff on-site during final phases of construction and then start-up
- IRWD Operations combined experience in sewage treatment and biosolids management: over **160 years**
- Knowledgeable Supervisors have developed training programs for newer staff



Irvine Ranch Water District

5

5

## Process Overview - Sludge Thickening

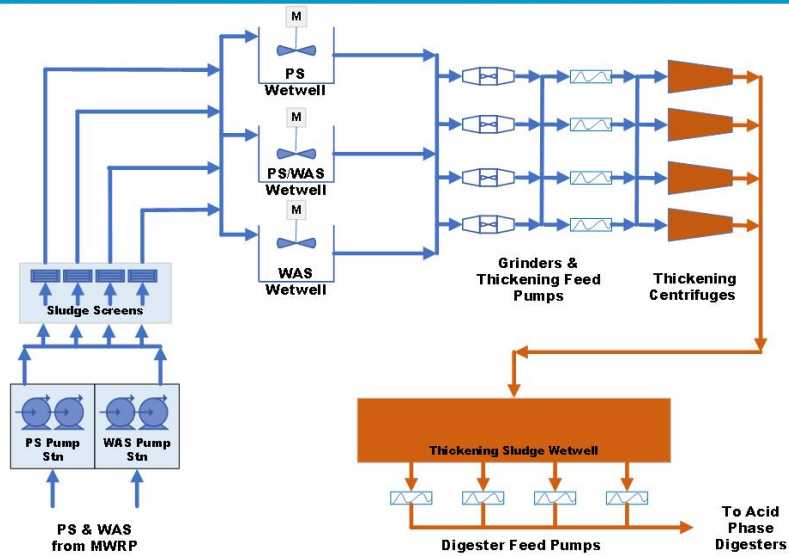

Irvine Ranch Water District

6

6

# Sludge Thickening Operations



Irvine Ranch Water District

7

7

# Process Overview – Digestion

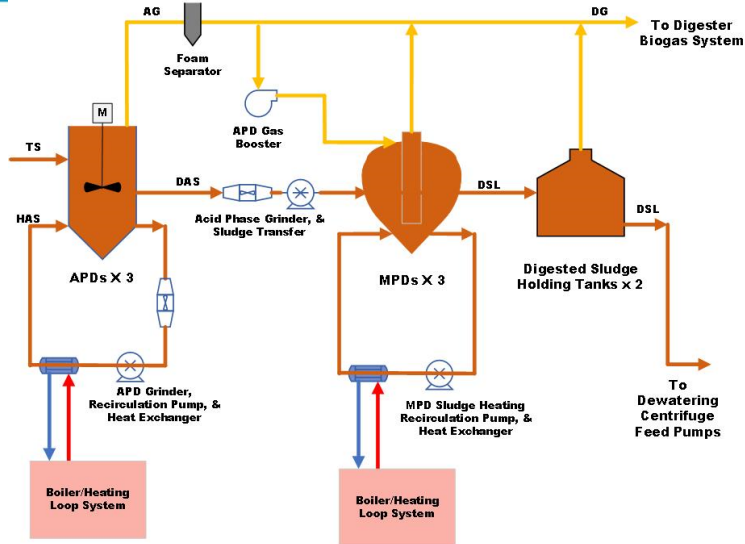

Irvine Ranch Water District

8

8



## Digestion Operations



Irvine Ranch Water District

9

9

## Ancillary / Support Systems



*Gas Treatment, Microturbines & Flare*



*Odor Control System*

Irvine Ranch Water District

10

10

## Sludge and Biogas Sampling



Irvine Ranch Water District

11

11

## Sludge Sample Analysis



Irvine Ranch Water District

12

12



## Process Overview – Dewatering and Drying

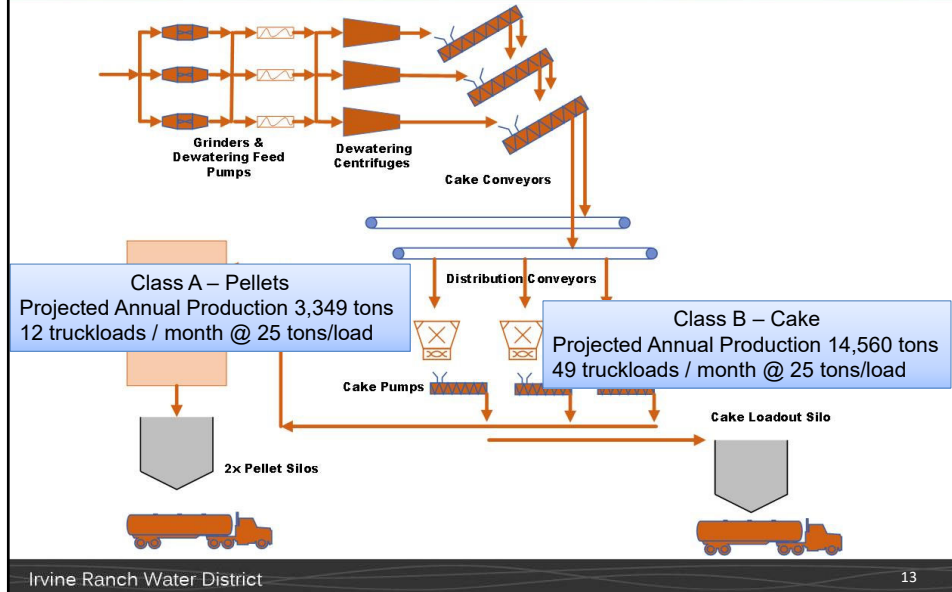

13

## Biosolids – Class A or Class B

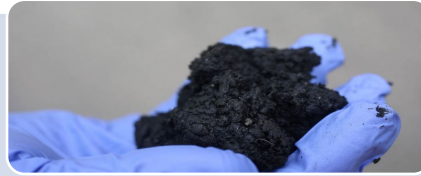

### Class A

- Diverse market options
- Reduced volume of material to be handled
- Lower transportation costs
- Reduced truck traffic in and out of the facility

### Class B

- Fewer outlet options
- Levels of pathogens higher than Class A, more volume to handle
- Disposal is more expensive
- Higher truck traffic in and out of the facility

14

## Sludge Load Out Bay & Truck Scale

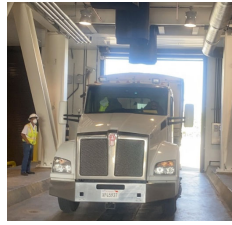

Irvine Ranch Water District

15

15

## Update on Developing Outlets for Pellets



16

16

## Biosolids Program's Prioritized Goals

1. Safety
2. Compliance
3. Reliability
4. Customer Management



Irvine Ranch Water District

17

## Marketing Pellets

Currently utilizing a composting outlet (under a joint contract with SOCWA)

### *Markets under consideration:*

- Bulk Agriculture
- Bulk Horticulture
- Fertilizer Blenders (Agricultural, Ornamental and Retail)
- Soil Blenders (Retail and Landscape)
- Energy

Irvine Ranch Water District

18

18

## Bulk Agriculture & Horticulture



Biosolids being unloaded in Yuma, AZ



### Bulk Agriculture:

- Use of Biosolids on “feed, fodder, and fiber crops
- Class A or Class B

### Bulk Horticulture:

- Landscaping and nursery production (sod production, etc.)
- Class A only

19

## Fertilizer & Soil Blenders



### Fertilizer Blenders:

- Mix & resell fertilizer to end users
- Have experience with Encina Wastewater Authority & City of Corona dried biosolids
- Class A only



### Soil Blenders:

- Mix native soils, organics and other ingredients to produce custom soil blends
- Class A only

20

## Brokers

- Contracted to manage all or most of the production in exchange for a share of revenue
- Broker manages all aspects of sales and marketing
- May or may not include transportation responsibilities
- Typically includes a provision to manage off-spec product at a fee

21

## Pellet Marketing – Active Outlet Leads

- Landscape Contractors – Used similar product and provided feedback
- UCI – Working with staff to use pellets on properties as fertilizer
- Market Research Contact List
  - Nutrients PLUS – Interested in taking full production
  - Other contacts require a sample of actual product before proceeding

22



## What Do Customers Want?

- Reliability and availability of supply
- Consistency of product
  - Size, Bulk Density, Uniformity, & Hardness
  - Moisture Content
  - Chemical Characteristics
  - Nutrient Value - Nitrogen, Phosphorus, & Potassium (N-P-K) projected at 4.0-2.0-0.2
  - No Odor or Dust

23

## Biosolids Project Cost Summary

Total cost for Design, Construction, and Startup is \$248M

Design consultant engineering / CEQA: \$15M

Construction management: \$38M

Construction: \$185M

Staff Labor: \$10M



24

# Schedule

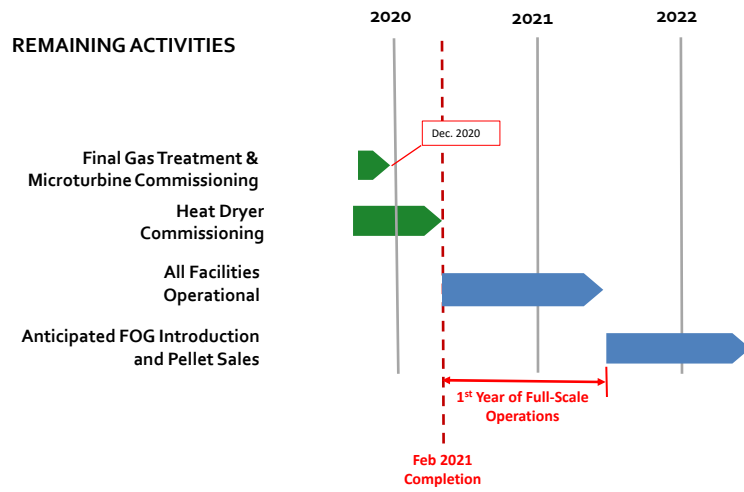

25

# Questions



26

Note: This page is intentionally left blank.



October 26, 2020  
Prepared and  
submitted by: L. Bonkowski  
Approved by: Paul A. Cook *P.A.C.*

CONSENT CALENDAR

BOARD MEETING MINUTES

SUMMARY:

Provided are the minutes of the October 12, 2020 Regular Board meeting for approval.

FISCAL IMPACTS:

None.

ENVIRONMENTAL COMPLIANCE:

Not applicable.

COMMITTEE STATUS:

Not applicable.

RECOMMENDATION:

THAT THE MINUTES OF THE OCTOBER 12, 2020 REGULAR BOARD MEETING BE APPROVED AS PRESENTED.

LIST OF EXHIBITS:

Exhibit "A" – October 12, 2020 Minutes

Note: This page is intentionally left blank.

EXHIBIT "A"

MINUTES OF REGULAR MEETING – October 12, 2020

The regular meeting of the Board of Directors of the Irvine Ranch Water District (IRWD) was called to order at 5:00 p.m. by President Matheis on October 12, 2020 via teleconference pursuant to the provisions of the Governor's Executive Orders N-25-20 and N-29-20 due to COVID-19. Members of the public did not attend this meeting in person.

Directors Present: Reinhart, Swan, Withers, LaMar and Matheis.

Directors Absent: None.

Also Present: General Manager Cook, Executive Director of Technical Services Burton, Executive Director of Water Policy Weghorst, Executive Director of Finance and Administration Clary, Director of Treasury and Risk Management Jacobson, Executive Director of Operations Chambers, General Counsel Collins, Director of Public Affairs Beeman, Director of Human Resources Roney, Director of Water Quality and Regulatory Compliance Colston, Director of Recycling Operations Zepeda, Director of Information Services Malone, Director of Water Resources Sanchez, Government Relations Officer/Deputy General Counsel Compton, Secretary Bonkowski, State Senator John M.W. Moorlach, Mr. Bruce Newell, and members of staff and the public.

WRITTEN AND ORAL COMMUNICATIONS: None.

PRESENTATION

COMMENDATION FOR THE HONORABLE JOHN M.W. MOORLACH

President Matheis reported that she was delighted that State Senator John Moorlach had authored Senate Bill 1386 and that this bill moved forward through the legislature without a single opposition vote. Directors Swan, LaMar, Withers and Reinhart thanked the Senator for his efforts on this bill for local governments. Senator Moorlach thanked Government Relations Officer/Deputy General Counsel for her continuous efforts, said he was honored to author the bill, and appreciated the working relationship with the District. On MOTION by Matheis, seconded by Withers and unanimously carried by a roll call vote (5-0) Withers, Matheis, Reinhart, Swan, and LaMar voting aye, and 0 noes, THE FOLLOWING RESOLUTION WAS ADOPTED BY TITLE:

RESOLUTION NO. 2020-18

RESOLUTION OF THE BOARD OF DIRECTORS  
OF IRVINE RANCH WATER DISTRICT COMMENDING  
THE HONORABLE JOHN M. W. MOORLACH FOR  
AUTHORING SENATE BILL 1386

## CONSENT CALENDAR

On MOTION by Withers, seconded by Swan, and unanimously carried by a roll call vote (5-0) Withers, Matheis, Reinhart, Swan, and LaMar voting aye, and 0 noes, CONSENT CALENDAR ITEMS 3 THROUGH 7 WERE APPROVED AS FOLLOWS:

### CONSENT CALENDAR (CONTINUED)

4. BOARD MEETING MINUTES

Recommendation: That the minutes of the September 28, 2020 Regular Board meeting be approved as presented.

5. RATIFY/APPROVE BOARD OF DIRECTORS' ATTENDANCE AT MEETINGS AND EVENTS

Recommendation: That the Board ratify/approve the meetings and events for Mary Aileen Matheis, Peer Swan, Doug Reinhart, Steve LaMar, and John Withers, as described.

6. 2020 LEGISLATIVE AND REGULATORY UPDATE

Recommendation: Receive and file.

7. ELECTION OF THE INDEPENDENT SPECIAL DISTRICTS OF ORANGE COUNTY 2021-2022 OFFICERS

Recommendation: That the Board review the candidates for the Independent Special Districts of Orange County (ISDOC) to serve on its Executive Committee for the 2021-2022 term, and authorize IRWD to cast its ballot in favor of Mark Monin (El Toro Water District) for President and authorize the District to submit its ballot to ISDOC no later than the October 23, 2020, deadline.

## ACTION CALENDAR

### 3.7 MG ZONE 1 RESERVOIR FINAL ACCEPTANCE

Using a PowerPoint presentation, Senior Engineer McGehee reported that the 3.7 Million Gallon (MG) Zone 1 Reservoir project is now complete. Mr. McGehee provided the background of the project noting that this reservoir serves as the primary storage for the Zone 1 domestic water system and as the forebay for the onsite East Irvine Zone 1 to 3 and South County emergency booster pump stations. The project included the construction of a new 3.7 MG aboveground prestressed concrete reservoir, which will increase the overall domestic water storage in the Zone 1 system and will provide greater operational flexibility and storage redundancy in IRWD's largest domestic water service area.

Mr. McGehee reported on the project challenges and noted that the site blends in with the look and feel of the adjacent residential neighborhoods.

Director Reinhart reported that the design of the project was reviewed by the Engineering and Operations Committee and recognized that it was a difficult project to accomplish. On MOTION by Swan, seconded by Reinhart, and unanimously carried by a roll call vote (5-0) Withers, Matheis, Reinhart, Swan, and LaMar voting aye, and 0 noes, THE BOARD ACCEPTED CONSTRUCTION OF THE 3.7 MG ZONE 1 RESERVOIR, AUTHORIZED THE GENERAL MANAGER TO FILE A NOTICE OF COMPLETION, AND AUTHORIZED THE PAYMENT OF THE RETENTION 35 DAYS AFTER THE DATE OF RECORDING THE NOTICE OF COMPLETION FOR PROJECT 06401.

#### REVISED IRWD POLICY PRINCIPLES REGARDING PFAS CONTAMINANTS

Staff updated the IRWD policy position paper pertaining to issues associated with per- and polyfluoroalkyl substances, also known as PFAS, which at high enough concentrations, these contaminants can pose threats to human health. The policy paper has been revised to reflect current conditions and the status of regulations being developed that will likely have impacts on IRWD as well as water and sanitation agencies throughout Orange County and the United States. On MOTION by Reinhart, seconded by LaMar, and unanimously carried by a roll call vote (5-0) Withers, Matheis, Reinhart, Swan, and LaMar voting aye, and 0 noes, THE BOARD ADOPTED THE REVISED IRWD POLICY PRINCIPLES REGARDING PFAS CONTAMINANTS DATED OCTOBER 12, 2020.

#### OTHER BUSINESS

##### GENERAL MANAGER'S REPORT

General Manager Cook reported that relative to COVID-19, there is an additional case, for a total of seven employees who have contracted this virus, and noted that there was no transmission among these cases.

Mr. Cook said that he received word from the Customer Service Department that there are currently 2,000 accounts delinquent for a total of \$1.1 million outstanding. Additionally, he said that they have issued 300 temporary variances due to additional individuals living in a single residence. He said that the overall Customer Service rating from surveys is at 94%.

##### DIRECTORS' COMMENTS

Director Withers said that he had no comments this evening.

Director LaMar reported on his attendance at a WACO meeting, a MWDOC workshop with MWD Directors, a Southern California Executive Committee, and ACWA meetings.

Director Swan reported on his attendance at a Groundwater Banking JPA Finance Committee meeting with Director Reinhart in attendance, a CASA Federal Legislation meeting, a WACO meeting, an OCBC Government Affairs Committee meeting, a MWDOC Planning meeting, and a MWDOC Workshop with MWD Directors.

Director Reinhart reported on his attendance at a Groundwater Banking JPA Finance Committee meeting, a SOCWA Board meeting, a MWDOC Workshop with MWD Directors, a WACO meeting, an OCWD Board meeting and an OCWD Communication and Legislation Liaison Committee meeting.

Director Matheis reported on her attendance at a UWI Planning meeting and said she was looking forward to next week's ISDOC quarterly meeting as well as a Southern California Coalition meeting.

COMMUNITY UPDATES

The District's consultant, Mr. Bruce Newell, said he had nothing to report this evening.

ADJOURNMENT

President Matheis adjourned the meeting at 5:58 p.m.

APPROVED and SIGNED this 26<sup>th</sup> day of October 2020.

---

President, IRVINE RANCH WATER DISTRICT

---

Secretary IRVINE RANCH WATER DISTRICT

APPROVED AS TO FORM:

---

Claire Hervey Collins, General Counsel  
Hanson Bridgett LLP

October 26, 2020  
Prepared and  
submitted by: K. Swan  
Approved by: Paul A. Cook



CONSENT CALENDAR

RATIFY/APPROVE BOARD OF DIRECTORS'  
ATTENDANCE AT MEETINGS AND EVENTS

SUMMARY:

Pursuant to Resolution 2006-29 adopted on August 28, 2006, the following events and meetings require approval by the Board of Directors:

Steven LaMar

October 30 OCSD Virtual State of the District

Mary Aileen Matheis

October 20 California Water Policy's Virtual Streamin' Series: Time for Transformative Water Leadership  
October 21 Orange County Water Association's Monthly Industry Insight Meeting  
October 22 OCBC's 26<sup>th</sup> Annual Economic Forecast Virtual Conference  
October 22 Water UCI's Virtual Panel Discussion on the Links between COVID-19 and our Water Systems  
October 27 Water UCI's Virtual Overview of the California Water Resilience Portfolio

Peer Swan

October 2 OCBC Advocacy & Government Affairs Committee Meeting  
October 22 OCBC's 26<sup>th</sup> Annual Economic Forecast Virtual Conference

John Withers

October 9 Santa Margarita Water District's Virtual Dedication of Trampas Canyon Dam and Reservoir  
October 20 California Water Policy's Virtual Streamin' Series: Time for Transformative Water Leadership  
October 22 Water UCI's Virtual Panel Discussion on the Links between COVID-19 and our Water Systems  
October 27 Water UCI's Virtual Overview of the California Water Resilience Portfolio

RECOMMENDATION:

THAT THE BOARD RATIFY/APPROVE THE MEETINGS AND EVENTS FOR MARY AILEEN MATHEIS, PEER SWAN AND JOHN WITHERS AS DESCRIBED HEREIN.

LIST OF EXHIBITS:

None.

Note: This page is intentionally left blank.



October 26, 2020

Prepared by: D. Pardee / C. Smithson

Submitted by: C. Clary

Approved by: Paul A. Cook



CONSENT CALENDAR

IRWD STRATEGIC MEASURES

SUMMARY:

Provided as Exhibit “A” are the IRWD Strategic Measures and informational items for the Board’s review. These measures are intended to reflect the critical performance measures that gauge the District’s key business objectives.

BACKGROUND:

The proposed strategic measures document summarizes a number of operating performance, financial, customer and other key measures important to the ongoing operation of the District. These measures were selected and designed to provide a “snapshot” view of the measures that would be of interest to the Board.

FISCAL IMPACTS:

Not applicable.

ENVIRONMENTAL COMPLIANCE:

Not applicable.

RECOMMENDATION:

RECEIVE AND FILE.

LIST OF EXHIBITS:

Exhibit “A” – Q1 2021 Strategic Measures

Note: This page is intentionally left blank.

# IRVINE RANCH WATER DISTRICT

## Operational Performance Measures

Data as of September 30, 2020

Potable Water Production FYTD  
(AF)

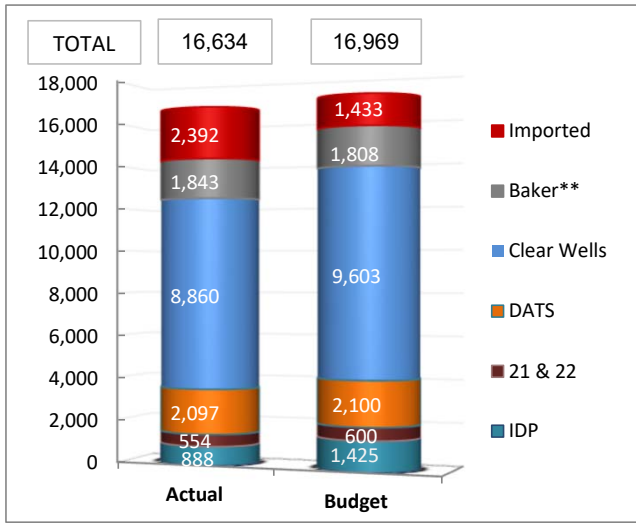

Non-Potable Water Production FYTD  
(AF)

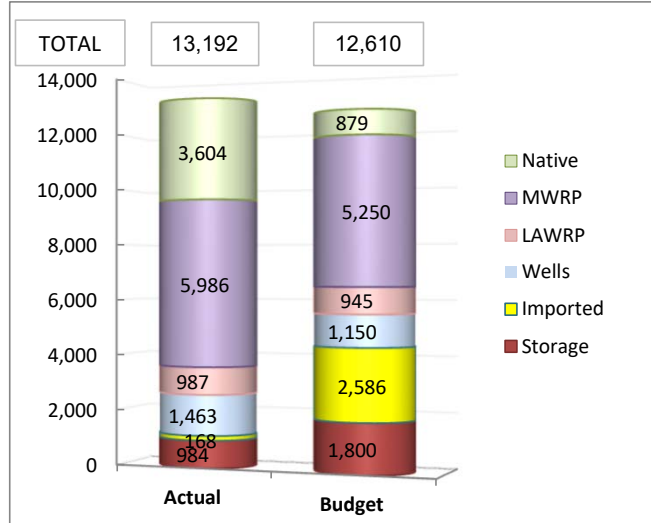

\*\* Baker was supplied with 1,675 AF of native water. IRWD received 404 AF (24.1%) This is included in both potable and non potable production.

## Non-Potable Reservoir Storage

(AF)

### Irvine Lake

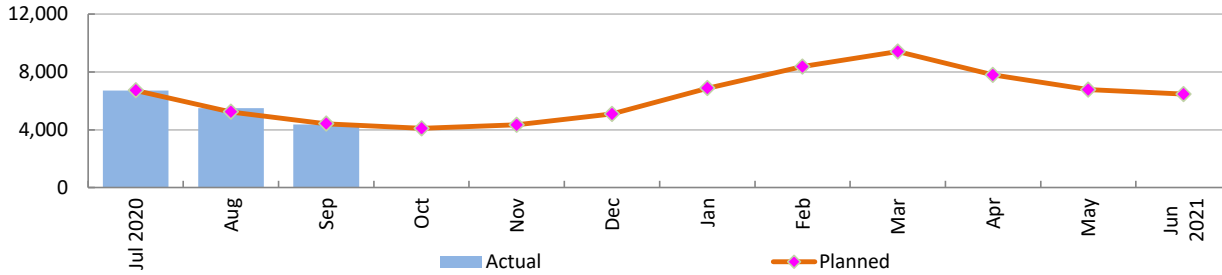

### Recycled

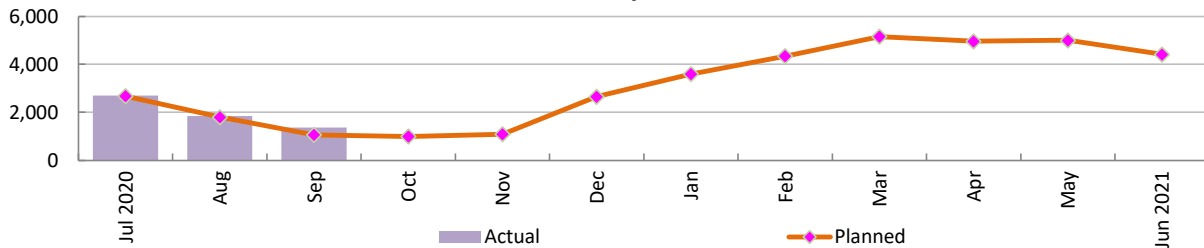

### Odor Complaints (FY by quarter)

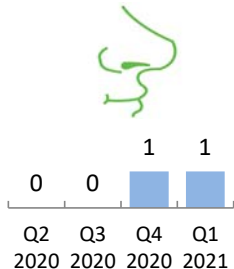

### OSHA Recordables Incidents

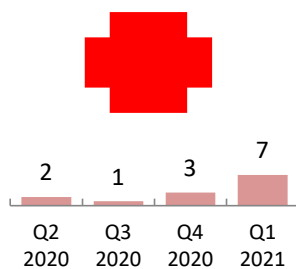

### Regulatory Compliance Incidents

AQMD	1	4	0	6
Plants	1	1	1	1
Sewer Spills	2	0	0	1
	Q2 2020	Q3 2020	Q4 2020	Q1 2021

# IRVINE RANCH WATER DISTRICT

## Other Statistical Information

Data as of September 30, 2020

### Banked Water

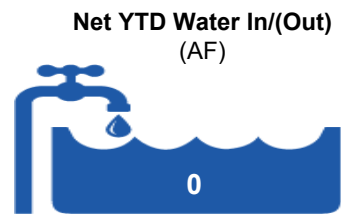
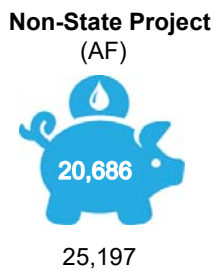
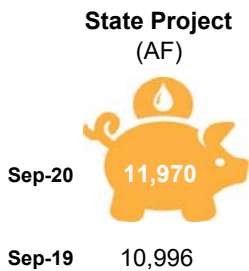

\*Calendar Year including extraordinary supply received.

### Certificates of Occupancies FYTD

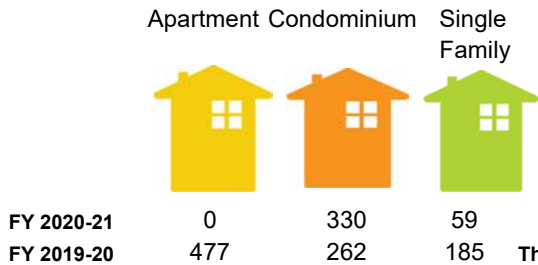

### Total Potable Water

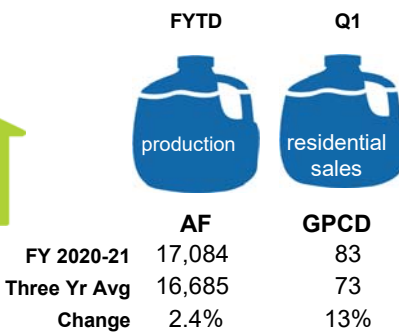

### Acre-Feet Per Acre Irrigation

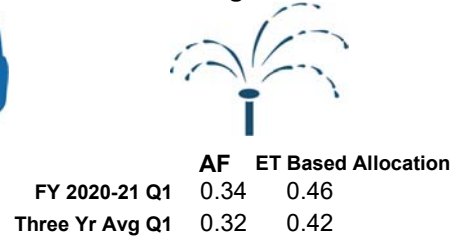

### Potable Sales by Tier FYTD

(in thousands)

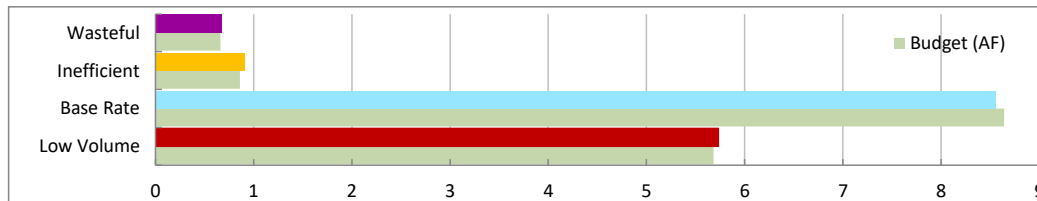

### % of Customers by Tier

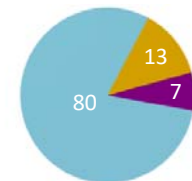

### Non-Potable Sales by Tier FYTD

(in thousands)

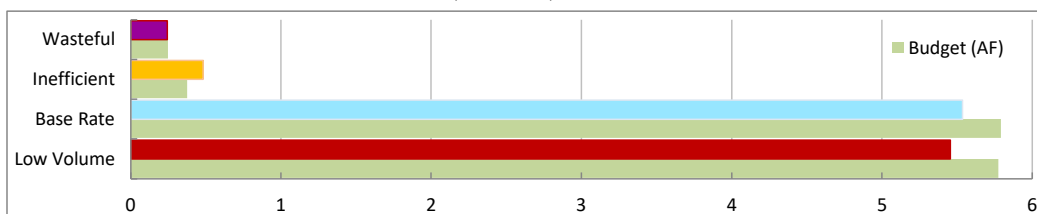

### % of Customers by Tier

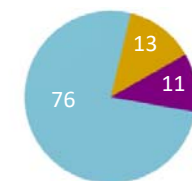

### Imported Water Purchases FYTD

(in thousands)

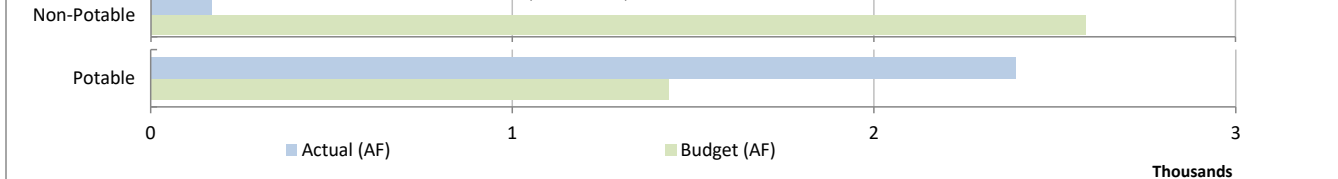

### Website Hits

(in thousands)

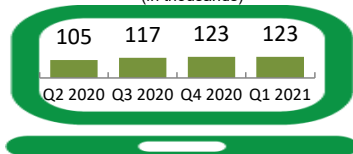

### Customer Satisfaction Index\*\*

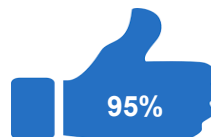

\*\* 12 month rolling average

October 26, 2020

Prepared by: J. Davis / T. Fournier

Submitted by: R. Jacobson / C. Clary

Approved by: Paul A. Cook



## CONSENT CALENDAR

### SEPTEMBER 2020 TREASURY REPORT

#### SUMMARY:

The following is submitted for the Board's information and approval:

- A. The September 2020 Investment Summary Report. This Investment Summary Report conforms with the 2020 Investment Policy and provides sufficient liquidity to meet estimated expenditures during the next six months, as outlined in Exhibit "A";
- B. The Summary of Fixed and Variable Rate Debt as of September 30, 2020, as outlined in Exhibit "B";
- C. The Monthly Interest Rate Swap Summary as of September 30, 2020, as outlined in Exhibit "C";
- D. The September 30, 2020 Disbursement Summary of warrants 411399 through 412074, wire transfers, Workers' Compensation distributions, payroll withholding distributions, and voided checks in the total amount of \$16,965,031, as outlined in Exhibit "D";
- E. The Summary of Payroll ACH payments in the total amount of \$2,125,589, as outlined in Exhibit "E"; and
- F. The Disclosure Report of Reimbursements to Board members and staff for September 2020, detailing payments or reimbursements for individual charges of \$100.00 or more per transaction, as outlined in Exhibit "F".

#### FISCAL IMPACTS:

As of September 30, 2020, the book value of the investment portfolio was \$401,328,712, with a 1.13% rate of return and a market value of \$404,290,338. Based on IRWD's September 30, 2020 quarterly real estate investment rate of return of 8.02%, the weighted average return for the fixed income and real estate investments was 3.26%.

As of September 30, 2020, the outstanding principal amount of fixed and variable rate debt was \$654,245,000. The monthly weighted average all-in variable rate was 0.38%. Including IRWD's weighted average fixed rate bond issues of 3.69% and the previous month's negative cash accruals from fixed payer interest rate swaps, which hedge a portion of the District's variable rate debt, the total average debt rate was 2.89%.

Payroll ACH payments totaled \$2,125,589, and wire transfers, all other ACH payments, and checks issued for debt service, accounts payable, payroll, and water purchases for September totaled \$16,965,031.

ENVIRONMENTAL COMPLIANCE:

This item is not a project as defined in the California Environmental Quality Act Code of Regulations, Title 14, Chapter 3, Section 15378.

COMMITTEE STATUS:

This item was not submitted to a Committee; however, the investment and debt reports are submitted to the Finance and Personnel Committee on a monthly basis.

RECOMMENDATION:

THAT THE BOARD RECEIVE AND FILE THE TREASURER'S INVESTMENT SUMMARY REPORT, THE SUMMARY OF FIXED AND VARIABLE RATE DEBT, AND DISCLOSURE REPORT OF REIMBURSEMENTS TO BOARD MEMBERS AND STAFF, APPROVE THE SEPTEMBER 2020 SUMMARY OF PAYROLL ACH PAYMENTS IN THE TOTAL AMOUNT OF \$2,125,589, AND APPROVE THE SEPTEMBER 2020 ACCOUNTS PAYABLE DISBURSEMENT SUMMARY OF WARRANTS 411399 THROUGH 412074, WORKERS' COMPENSATION DISTRIBUTIONS, WIRE TRANSFERS, PAYROLL WITHHOLDING DISTRIBUTIONS AND VOIDED CHECKS IN THE TOTAL AMOUNT OF \$16,965,031.

LIST OF EXHIBITS:

- Exhibit "A" – Investment Summary Report
- Exhibit "B" – Summary of Fixed and Variable Debt
- Exhibit "C" – Monthly Interest Rate Swap Summary
- Exhibit "D" – Monthly Summary of District Disbursements
- Exhibit "E" – Monthly Payroll ACH Summary
- Exhibit "F" – Disclosure of Reimbursements to Board Members and Staff

Exhibit "A"  
**Irvine Ranch Water District  
Investment Portfolio Summary  
September 2020**

**Monthly Fixed Income Yield**

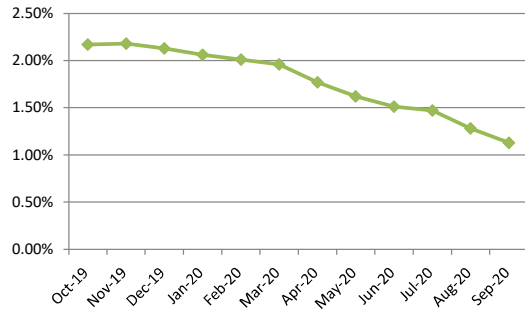

**Portfolio Distribution**

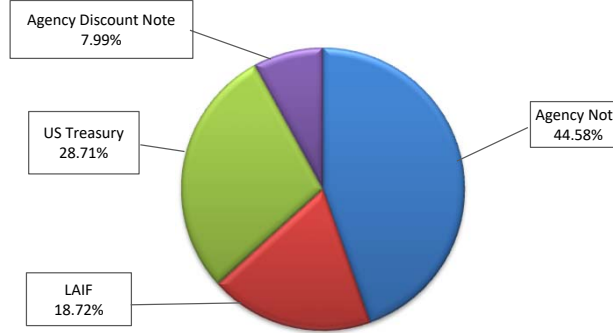

**Investment Summary**

Type	PAR	Book Value	Market Value
Agency Note	178,550,000	179,225,915	180,450,228
US Treasury	115,000,000	115,141,227	116,631,200
LAIF	75,000,000	75,000,000	75,308,590
Agency Discount Note	32,000,000	31,961,571	31,900,320
<b>Grand Total</b>	<b>400,550,000</b>	<b>401,328,712</b>	<b>404,290,338</b>

**Weighted Average Return  
Including Real Estate Portfolio**

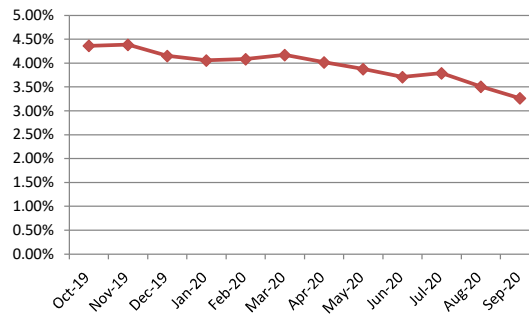

**Maturity Distribution**

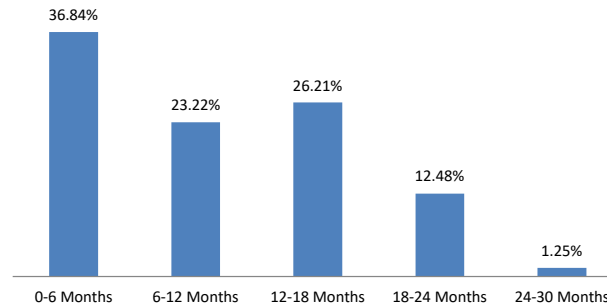

**Top Issuers**

Issuer	PAR	% Portfolio
US Treasury	115,000,000	28.71%
Fed Home Loan Bank	82,000,000	20.47%
State of California Tsy	75,000,000	18.72%
Fed Farm Credit Bank	60,000,000	14.98%
Fed Home Loan Mortgage Corp	40,000,000	9.99%
Fed Natl Mortgage Assoc	28,550,000	7.13%
<b>Grand Total</b>	<b>400,550,000</b>	<b>100.00%</b>

IRVINE RANCH WATER DISTRICT  
INVESTMENT SUMMARY REPORT

09/30/20

SETTLMT	Call Schedule	Initial Call	Maturity Date	Rating	INVESTMENT TYPE	INSTITUTION / ISSUER	PAR Amount	COUPON DISCOUNT	YIELD	ORIGINAL COST	CARRY VALUE	MARKET VALUE <sup>(1)</sup> 9/30/2020	UNREALIZED <sup>(2)</sup> GAIN/(LOSS)
07/24/20			10/01/20		LAIF	State of California Tsy.	\$75,000,000		0.690%	\$75,000,000.00	\$75,000,000.00	75,308,590.05	308,590.05
10/31/17	NA	NA	10/30/20	Aaa/NR/AAA	FNMA - Note	Fed Natl Mortgage Assoc	5,550,000	1.850%	1.850%	5,550,000.00	5,550,000.00	5,557,881.00	7,881.00
03/31/20	NA	NA	10/30/20	NR	FHLB - Discount Note	Fed Home Loan Bank	5,000,000	0.150%	0.153%	4,995,562.50	4,998,104.17	4,999,750.00	1,645.83
09/28/18	NA	NA	10/31/20	Aaa/NR/AAA	Treasury - Note	US Treasury	5,000,000	1.750%	2.847%	4,889,453.13	4,783,247.11	5,006,700.00	223,452.89
03/16/20	NA	NA	11/18/20	NR	FHLB - Discount Note	Fed Home Loan Bank	7,000,000	0.530%	0.540%	6,974,545.28	6,987,118.06	6,999,370.00	12,251.94
11/30/17	NA	NA	11/24/20	Aaa/AA+/AAA	FFCB - Note	Fed Farm Credit Bank	5,000,000	1.850%	1.964%	4,983,550.00	4,999,185.05	5,012,950.00	13,764.95
12/20/17	NA	NA	12/28/20	Aaa/AA+/AAA	FNMA - Note	Fed Natl Mortgage Assoc	5,000,000	1.875%	2.023%	4,978,400.00	4,996,282.61	5,020,250.00	23,967.39
11/09/18	NA	NA	12/31/20	Aaa/NR/AAA	Treasury - Note	US Treasury	5,000,000	2.375%	2.958%	4,939,843.75	4,993,008.66	5,027,850.00	34,841.34
03/31/20	NA	NA	01/19/21	NR	FHLB - Discount Note	Fed Home Loan Bank	5,000,000	0.200%	0.204%	4,991,833.33	4,995,222.22	4,998,650.00	3,427.78
10/12/18	NA	NA	01/31/21	Aaa/NR/AAA	Treasury - Note	US Treasury	10,000,000	1.375%	2.890%	9,664,843.76	9,951,438.17	10,041,000.00	89,561.83
12/14/18	NA	NA	02/16/21	Aaa/AA+/AAA	FHLMC - Note	Fed Home Loan Mortgage Corp	5,000,000	2.375%	2.806%	4,954,750.00	4,991,120.75	5,041,900.00	50,779.25
08/13/20	NA	NA	02/25/21	Aaa/NR/AAA	Treasury - Bill	US Treasury	10,000,000	0.110%	0.112%	9,994,011.11	9,995,508.33	9,995,900.00	391.67
12/14/18	NA	NA	02/28/21	Aaa/NR/AAA	Treasury - Note	US Treasury	5,000,000	2.000%	2.755%	4,919,515.95	4,983,244.96	5,039,050.00	55,805.04
02/12/19	NA	NA	03/12/21	Aaa/AA+/NR	FHLB - Note	Fed Home Loan Bank	10,000,000	2.500%	2.516%	9,996,500.00	9,999,252.96	10,107,300.00	108,047.04
02/25/19	NA	NA	03/12/21	Aaa/AA+/NR	FHLB - Note	Fed Home Loan Bank	5,000,000	2.375%	2.549%	4,982,700.00	4,996,243.16	5,049,700.00	53,456.84
06/17/19	NA	NA	03/17/21	Aaa/AA+/NR	FFCB - Note	Fed Farm Credit Bank	5,000,000	1.950%	1.938%	5,001,050.00	5,000,274.41	5,041,650.00	41,375.59
02/28/20	NA	NA	04/13/21	Aaa/AA+/AAA	FNMA - Note	Fed Natl Mortgage Assoc	3,000,000	2.500%	1.185%	3,043,950.00	3,030,872.20	3,037,410.00	6,537.80
06/14/19	NA	NA	04/30/21	Aaa/AA+/AAA	FNMA - Note	Fed Natl Mortgage Assoc	5,000,000	1.750%	1.913%	4,985,000.00	4,995,386.30	5,046,850.00	51,463.70
12/05/19	NA	NA	04/30/21	Aaa/NR/AAA	Treasury - Note	US Treasury	5,000,000	2.250%	1.650%	5,041,406.25	5,017,063.90	5,062,500.00	45,436.10
09/13/19	NA	NA	05/15/21	Aaa/NR/AAA	Treasury - Note	US Treasury	5,000,000	2.625%	1.757%	5,071,093.75	5,026,339.65	5,077,550.00	51,210.35
03/02/20	NA	NA	05/31/21	Aaa/NR/AAA	Treasury - Note	US Treasury	10,000,000	2.125%	1.186%	10,115,711.10	10,084,685.27	10,133,200.00	48,514.73
06/11/20	NA	NA	06/09/21	NR	FHLB - Discount Note	Fed Home Loan Bank	5,000,000	0.190%	0.193%	4,990,420.85	4,993,376.40	4,996,150.00	2,773.60
09/18/19	NA	NA	06/11/21	Aaa/AA+/NR	FHLB - Note	Fed Home Loan Bank	5,000,000	2.250%	1.786%	5,039,300.00	5,015,732.44	5,073,350.00	57,617.56
01/16/20	NA	NA	06/30/21	Aaa/NR/AAA	Treasury - Note	US Treasury	5,000,000	1.125%	1.594%	4,966,406.25	4,982,791.90	5,037,500.00	54,708.10
07/26/19	NA	NA	07/19/21	Aaa/AA+/AAA	FFCB - Note	Fed Farm Credit Bank	5,000,000	1.875%	1.927%	4,995,000.00	4,997,990.33	5,068,800.00	70,809.67
08/13/20	NA	NA	08/12/21	NR	FFCB - Discount Note	Fed Farm Credit Bank	10,000,000	0.140%	0.142%	9,985,844.44	9,987,750.00	9,906,400.00	(81,350.00)
08/13/20	NA	NA	08/13/21	Aaa/NR/NR	FHLB - Note	Fed Home Loan Bank	10,000,000	0.125%	0.133%	9,999,220.00	9,999,324.71	9,989,500.00	(9,824.71)
08/01/19	NA	NA	08/31/21	Aaa/NR/AAA	Treasury - Note	US Treasury	5,000,000	1.125%	1.816%	4,929,687.50	4,969,140.11	5,044,900.00	75,759.89
09/17/20	NA	NA	09/17/21	NA	FHLB - Note	Fed Home Loan Bank	5,000,000	0.125%	0.132%	4,999,660.00	4,999,673.04	4,998,950.00	(723.04)
08/13/20	NA	NA	09/30/21	Aaa/AA+/NR	Treasury - Note	US Treasury	10,000,000	1.125%	0.133%	10,112,109.38	10,098,808.27	10,097,700.00	(1,108.27)
09/30/20	NA	NA	09/30/21	NA	FHLB - Note	Fed Home Loan Bank	10,000,000	0.125%	0.122%	10,000,336.80	10,000,335.88	10,000,336.80	0.92
08/13/20	NA	NA	10/07/21	Aaa/AA+/AAA	FNMA - Note	Fed Natl Mortgage Assoc	10,000,000	1.375%	0.143%	10,141,500.00	10,124,991.67	10,123,700.00	(1,291.67)
10/11/19	NA	NA	10/15/21	Aaa/AA+/NR	Treasury - Note	US Treasury	5,000,000	2.875%	1.540%	5,131,640.63	5,067,880.00	5,141,800.00	73,920.00
10/22/19	NA	NA	10/15/21	Aaa/AA+/AAA	FFCB - Note	Fed Farm Credit Bank	5,000,000	1.400%	1.642%	4,976,500.00	4,987,698.20	5,063,850.00	76,151.80
11/05/19	NA	NA	11/15/21	Aaa/NR/AAA	Treasury - Note	US Treasury	5,000,000	2.875%	1.610%	5,125,585.94	5,069,487.50	5,153,500.00	84,012.50
11/08/19	NA	NA	11/30/21	Aaa/AA+/NR	Treasury - Note	US Treasury	5,000,000	1.750%	1.680%	5,007,031.25	5,003,968.50	5,094,150.00	90,181.50
09/28/20	NA	NA	12/03/21	Aaa/AA+/AAA	FFCB - Note	Fed Farm Credit Bank	5,000,000	0.150%	0.120%	5,001,765.00	5,001,752.71	5,000,750.00	(1,002.71)
04/23/20	NA	NA	12/20/21	Aaa/AA+/NR	FHLB - Note	Fed Home Loan Bank	10,000,000	1.625%	0.309%	10,217,480.00	10,173,696.90	10,182,900.00	9,203.10
11/25/19	NA	NA	12/31/21	Aaa/NR/AAA	Treasury - Note	US Treasury	5,000,000	2.000%	1.619%	5,039,062.50	5,023,223.60	5,116,000.00	92,776.40
11/25/19	NA	NA	01/13/22	Aaa/NA/NR	FHLMC - Note	Fed Home Loan Mortgage Corp	5,000,000	2.375%	1.635%	5,077,250.00	5,046,449.04	5,144,350.00	97,900.96
08/14/20	NA	NA	01/13/22	Aaa/AA+/AAA	FHLMC - Note	Fed Home Loan Mortgage Corp	5,000,000	2.375%	0.147%	5,157,297.23	5,142,693.23	5,144,350.00	1,656.77
03/08/19	NA	NA	01/15/22	Aaa/AA+/NR	Treasury - Note	US Treasury	5,000,000	2.500%	2.460%	5,005,468.75	5,002,467.22	5,152,350.00	149,882.78
12/19/19	NA	NA	01/31/22	Aaa/NR/AAA	Treasury - Note	US Treasury	5,000,000	1.875%	1.641%	5,024,218.75	5,015,238.41	5,116,400.00	101,161.59
03/21/19	NA	NA	02/03/22	Aaa/AA+/AAA	FFCB - Note	Fed Farm Credit Bank	5,000,000	2.030%	2.361%	4,954,350.00	4,978,696.67	5,125,400.00	146,703.33
12/19/19	NA	NA	02/15/22	Aaa/NR/AAA	Treasury - Note	US Treasury	5,000,000	2.500%	1.652%	5,089,453.13	5,056,914.41	5,162,500.00	105,585.59
03/08/19	NA	NA	03/11/22	Aaa/AA+/NR	FHLB - Note	Fed Home Loan Bank	5,000,000	2.500%	2.549%	5,002,750.00	5,001,316.20	5,169,700.00	168,383.80
12/19/19	NA	NA	03/31/22	Aaa/NR/AAA	Treasury - Note	US Treasury	5,000,000	1.875%	1.645%	5,025,585.94	5,016,770.62	5,130,650.00	113,879.38
02/21/20	NA	NA	04/14/22	Aaa/AA+/AAA	FFCB - Note	Fed Farm Credit Bank	5,000,000	1.400%	1.414%	4,998,500.00	4,998,793.10	5,094,750.00	95,956.90
04/23/20	NA	NA	04/21/22	Aaa/AA+/NR	FFCB - Note	Fed Farm Credit Bank	10,000,000	1.580%	0.320%	10,250,200.00	10,197,616.76	10,219,700.00	22,083.24
04/27/20	Quarterly	10/27/20	04/27/22	Aaa/NA/NA	FHLMC - Note	Fed Home Loan Mortgage Corp	10,000,000	0.550%	0.550%	10,000,000.00	10,000,000.00	10,001,800.00	1,800.00
05/28/20	One Time	05/26/21	05/26/22	Aaa/NR/AAA	FHLMC - Note	Fed Home Loan Mortgage Corp	5,000,000	0.270%	0.270%	5,000,000.00	5,000,000.00	5,001,700.00	1,700.00
01/15/20	NA	NA	07/15/22	Aaa/AA+/NR	FFCB - Note	Fed Farm Credit Bank	5,000,000	1.600%	1.594%	5,000,750.00	5,000,536.18	5,128,100.00	127,563.82



IRVINE RANCH WATER DISTRICT  
INVESTMENT SUMMARY REPORT

09/30/20

SETTLMT	Call Schedule	Initial Call	Maturity Date	Rating	INVESTMENT TYPE	INSTITUTION / ISSUER	PAR Amount	COUPON DISCOUNT	YIELD	ORIGINAL COST	CARRY VALUE	MARKET VALUE <sup>(1)</sup> 9/30/2020	UNREALIZED <sup>(2)</sup> GAIN/(LOSS)
05/28/20	One Time	05/26/21	08/26/22	Aaa/NR/AAA	FHLMC - Note	Fed Home Loan Mortgage Corp	5,000,000	0.300%	0.300%	5,000,000.00	5,000,000.00	5,001,800.00	1,800.00
04/24/20	NA	NA	10/21/22	Aaa/NR/NR	FHLMC - Note	Fed Home Loan Mortgage Corp	5,000,000	0.550%	0.555%	5,000,000.00	5,000,000.00	5,000,550.00	550.00
<b>TOTAL INVESTMENTS</b>							<b>\$400,550,000</b>			<b>\$401,318,094.25</b>	<b>\$401,328,711.93</b>	<b>\$404,290,337.85</b>	<b>\$2,961,625.92</b>

Petty Cash		3,400.00
Ck Balance	Bank of America	1,136,349.00
		<u>\$402,457,843.25</u>

<sup>(1)</sup> LAIF market value is as of the most recent quarter-end as reported by LAIF.  
Security market values are determined using Bank of New York ("Trading Prices"), Bloomberg and/or broker dealer pricing.

<sup>(2)</sup> Gain (loss) calculated against carry value using the trading value provided by Bank of New York/or Brokers

<sup>(3)</sup> Real estate rate of return is based on most recent quarter end return

Outstanding Variable Rate Debt	\$259,100,000
Net Outstanding Variable Rate Debt (Less \$60 million fixed-payer swaps)	\$199,100,000
Investment Balance:	\$402,457,843
Investment to Variable Rate Debt Ratio:	202%
Portfolio - Average Number of Days To Maturity	267

	Investment Portfolio	Real Estate <sup>(3)</sup> Portfolio	Weighted Avg. Return
September	1.13%	8.02%	3.26%
August	1.28%	8.76%	3.51%
Change	-0.15%		-0.25%

This Investment Summary Report is in conformity with the 2020 Investment Policy and provides sufficient liquidity to meet the next six months estimated expenditures.  
\*S - Step up

IRVINE RANCH WATER DISTRICT  
SUMMARY OF MATURITIES

09/30/20

DATE	TOTAL	%	LAIF	Agency Notes	Agency Discount Notes	Municipal Bonds	US Treasury
09/20	\$75,000,000	18.72%	\$75,000,000				
10/20	15,550,000	3.88%		5,550,000	5,000,000		5,000,000
11/20	12,000,000	3.00%		5,000,000	7,000,000		
12/20	10,000,000	2.50%		5,000,000			5,000,000
01/21	15,000,000	3.74%			5,000,000		10,000,000
02/21	20,000,000	4.99%		5,000,000			15,000,000
03/21	20,000,000	4.99%		20,000,000			
04/21	13,000,000	3.25%		8,000,000			5,000,000
05/21	15,000,000	3.74%					15,000,000
06/21	15,000,000	3.74%		5,000,000	5,000,000		5,000,000
07/21	5,000,000	1.25%		5,000,000			
08/21	25,000,000	6.24%		10,000,000	10,000,000		5,000,000
<b>SUB-TOTAL</b>	<b>\$240,550,000</b>	<b>60.05%</b>	<b>\$75,000,000</b>	<b>\$68,550,000</b>	<b>32,000,000</b>		<b>\$65,000,000</b>
<b>13 Months - 3 YEARS</b>							
09/01/2021 - 11/30/2021	55,000,000	13.73%		30,000,000			25,000,000
12/01/2021 - 2/28/2022	50,000,000	12.48%		30,000,000			20,000,000
03/01/2022 - 05/31/2022	40,000,000	9.99%		35,000,000			5,000,000
06/01/2022 - 08/31/2022	10,000,000	2.50%		10,000,000			
09/01/2022 +	5,000,000	1.25%		5,000,000			
	-						
	-						
	-						
	-						
<b>TOTALS</b>	<b>\$400,550,000</b>	<b>100.00%</b>	<b>\$75,000,000</b>	<b>\$178,550,000</b>	<b>\$32,000,000</b>		<b>\$115,000,000</b>

% OF PORTFOLIO 18.72% 44.58% 7.99% 28.71%

Irvine Ranch Water District  
Summary of Real Estate - Income Producing Investments  
9/30/2020

	ACQUISITION DATE	PROPERTY TYPE	OWNERSHIP INTEREST	ORIGINAL COST	MARKET VALUE 6/30/2020	ANNUALIZED RATE OF RETURN QUARTER ENDED 9/30/2020
Sycamore Canyon	Dec-92	Apartments	Fee Simple	\$ 43,550,810	\$ 152,340,625	19.73%
Wood Canyon Villas	Jun-91	Apartments	Limited Partner	\$ 6,000,000	\$ 30,432,947	8.52%
ITC (230 Commerce)	Jul-03	Office Building	Fee Simple	\$ 5,739,845	\$ 11,964,600	8.09%
Waterworks Business Pk.	Nov-08	Research & Dev.	Fee Simple	\$ 8,630,577	\$ 9,363,600	6.40%
Sand Canyon Professional Center - Medical	Jul-12	Medical Office	Fee Simple	\$ 8,648,594	\$ 11,444,400	9.36%
Sand Canyon Professional Center - General Office	Sep-20	Office Building	Fee Simple	\$ 20,985,968	\$ 28,770,000	0.00%
<b>Total - Income Properties</b>				<b>\$ 93,555,794</b>	<b>\$ 215,546,172</b>	<b>11.68%</b>
<b>OTHER REAL ESTATE</b>						
<b>DESCRIPTION</b>						
Serrano Summit - Promissory Note Payment received - 8/12/20	Sep-17	NA	NA	\$ 85,352,804	\$ 85,352,804	4.00%
<b>Total - Income Producing Real Estate Investments</b>				<b>\$ 178,908,598</b>	<b>\$ 300,898,976</b>	<b>8.02%</b>

**IRVINE RANCH WATER DISTRICT INVESTMENT SUMMARY REPORT**  
**INVESTMENT ACTIVITY**  
**Sep-20**

**MATURITIES/SALES/CALLS**

**PURCHASES**

DATE	SECURITY TYPE	PAR	YIELD	Settlement Date	Maturity Date	SECURITY TYPE	PAR	YIELD TO MATURITY
9/4/2020	FFCB - Note	\$5,000,000	2.79%	9/10/2020	9/28/2020	Treasury - Bill	\$10,000,000	0.08%
9/16/2020	FHLB - Discount Note	\$5,000,000	0.49%	9/17/2020	9/17/2021	FHLB - Note	\$5,000,000	0.13%
9/28/2020	FNMA - Note	\$5,000,000	2.00%	9/28/2020	12/3/2021	FFCB - Note	\$5,000,000	0.12%
9/29/2020	Treasury - Bill	\$10,000,000	0.08%	9/30/2020	9/30/2021	FHLB - Note	\$10,000,000	0.12%

Exhibit "B"  
**Irvine Ranch Water District**  
**Summary of Fixed and Variable Rate Debt**  
**September 2020**

**Current Debt Mix By Type**

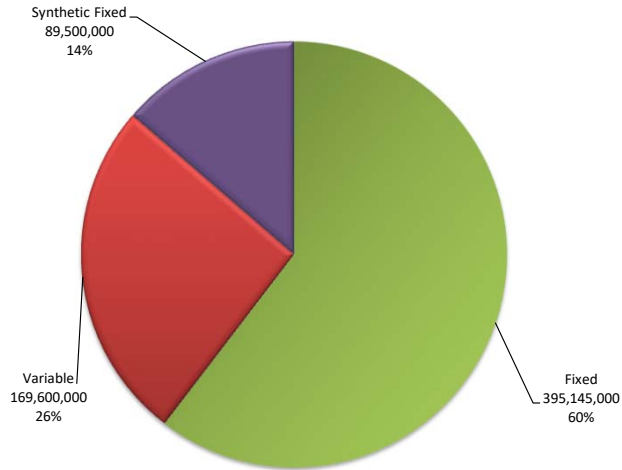

**Letters of Credit / Support**

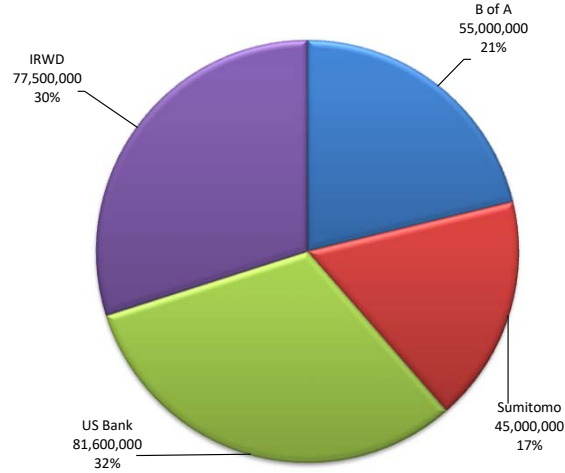

**Current Debt Rate Reset**

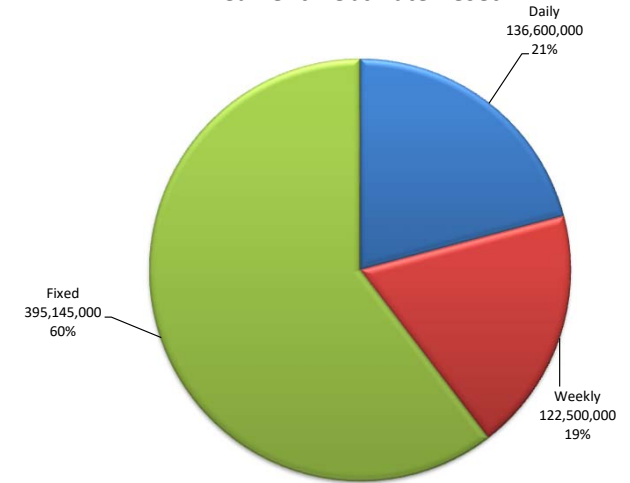

**Outstanding Par by Series**

Series	Issue Date	Maturity Date	Remaining Principal	Percent	Letter of Credit/Support	Rmkt Agent	Mode	Reset
Series 1993	05/19/93	04/01/33	\$26,600,000	4.07%	US Bank	BAML	Variable	Daily
Series 2008-A Refunding	04/24/08	07/01/35	\$45,000,000	6.88%	Sumitomo	BAML	Variable	Weekly
Series 2011-A-1 Refunding	04/15/11	10/01/37	\$46,500,000	7.11%	IRWD	Goldman	Variable	Weekly
Series 2011-A-2 Refunding	04/15/11	10/01/37	\$31,000,000	4.74%	IRWD	Goldman	Variable	Weekly
Series 2009 - A	06/04/09	10/01/41	\$55,000,000	8.41%	US Bank	US Bank	Variable	Daily
Series 2009 - B	06/04/09	10/01/41	\$55,000,000	8.41%	B of A	Goldman	Variable	Daily
2016 COPS	09/01/16	03/01/46	\$116,745,000	17.84%	N/A	N/A	Fixed	Fixed
2010 Build America Taxable Bond	12/16/10	05/01/40	\$175,000,000	26.75%	N/A	N/A	Fixed	Fixed
Series 2016	10/12/16	02/01/46	\$103,400,000	15.80%	N/A	N/A	Fixed	Fixed
<b>Total</b>			<b>\$654,245,000</b>	<b>100.00%</b>				

**IRVINE RANCH WATER DISTRICT**  
**SUMMARY OF FIXED & VARIABLE RATE DEBT**

September-20

ITN
Daily
Weekly

GENERAL BOND INFORMATION							LETTER OF CREDIT INFORMATION										TRUSTEE INFORMATION									
VARIABLE RATE ISSUES	Issue Date	Maturity Date	Principal Payment Date	Payment Date	Original Par Amount	Remaining Principal	Letter of Credit	Reimbursement Agreement Date	L/C Exp. Date	MOODY'S	S&P	FITCH	LOC Stated Amount	LOC Fee	Annual LOC Cost	Rmkt Agent	Reset	Rmkt Fees	Annual Cost	Trustee						
SERIES 1993	05/19/93	04/01/33	Apr 1	5th Bus. Day	\$38,300,000	\$26,600,000	US BANK	05/07/15	12/15/21	Aa3/VMIG1	AA-/A-1+	N/R	\$26,958,553	0.3300%	\$88,963	BAML	DAILY	0.10%	\$26,600	BANK OF NY						
SERIES 2008-A Refunding	04/24/08	07/01/35	Jul 1	5th Bus. Day	\$60,215,000	\$45,000,000	SUMITOMO	04/01/11	07/21/21	A1/P-1	A/A-1	A/F1	\$45,665,753	0.3150%	\$143,847	BAML	WED	0.07%	\$31,500	BANK OF NY						
SERIES 2011-A-1 Refunding	04/15/11	10/01/37	Oct 1	1st Bus. Day	\$60,545,000	\$46,500,000	N/A	N/A	N/A	Aa1/VMIG1	A-1+	AAA/F1+	N/A	N/A	N/A	Goldman	WED	0.13%	\$58,125	BANK OF NY						
SERIES 2011-A-2 Refunding	04/15/11	10/01/37	Oct 1	1st Bus. Day	\$40,370,000	\$31,000,000	N/A	N/A	N/A	Aa1/VMIG1	A-1+	AAA/F1+	N/A	N/A	N/A	Goldman	WED	0.13%	\$38,750	BANK OF NY						
SERIES 2009 - A	06/04/09	10/01/41	Oct 1	1st Bus. Day	\$75,000,000	\$55,000,000	US BANK	04/01/11	12/15/21	Aa2/VMIG 1	AA-/A-1+	AA/F1+	\$55,614,795	0.3300%	\$183,529	US Bank	DAILY	0.07%	\$38,500	US BANK						
SERIES 2009 - B	06/04/09	10/01/41	Oct 1	1st Bus. Day	\$75,000,000	\$55,000,000	B of A	04/01/11	05/16/22	Aa2/VMIG 1	A/A-1	A1/F1+	\$55,614,795	0.3000%	\$166,844	Goldman	DAILY	0.10%	\$55,000	US BANK						
					<b>\$349,430,000</b>	<b>\$259,100,000</b>	<b>SUB-TOTAL VARIABLE RATE DEBT</b>										<b>\$183,853,896</b>		<b>0.3172%</b>		<b>\$583,184</b>		<b>0.10%</b>		<b>\$248,475</b>	
																	(Wt. Avg)				(Wt. Avg)					
FIXED RATE ISSUES																										
2010 GO Build America Taxable Bonds	12/16/10	05/01/40	May (2025)	May/Nov	\$175,000,000	\$175,000,000	N/A	N/A	N/A	Aa1	AAA	NR	N/A	N/A	N/A	N/A	N/A	N/A	N/A	US BANK						
2016 COPS	09/01/16	03/01/46	Mar (2021)	Mar/Sept	\$116,745,000	\$116,745,000	N/A	N/A	N/A	NR	AAA	AAA	N/A	N/A	N/A	N/A	N/A	N/A	N/A	US BANK						
SERIES 2016	10/12/16	02/01/46	Feb (2022)	Feb/Aug	\$103,400,000	\$103,400,000	N/A	N/A	N/A	NR	AAA	AAA	N/A	N/A	N/A	N/A	N/A	N/A	N/A	BANK OF NY						
					<b>\$395,145,000</b>	<b>\$395,145,000</b>	<b>SUB-TOTAL FIXED RATE DEBT</b>																			
					<b>\$744,575,000</b>	<b>\$654,245,000</b>	<b>TOTAL- FIXED &amp; VARIABLE RATE DEBT</b>																			

Remarketing Agents			GO VS COP's		
Goldman	132,500,000	51%	GO:	537,500,000	82%
BAML	71,600,000	28%	COPS:	116,745,000	18%
US Bank	55,000,000	21%	Total	<u>654,245,000</u>	
	<u>259,100,000</u>				

LOC Banks		Breakdown Between Variable & Fixed Rate Mode	
SUMITOMO	45,000,000	Daily Issues	136,600,000 21%
BANK OF AMERICA	55,000,000	Weekly Issues	45,000,000 7%
US BANK	81,600,000	ITN Issues	77,500,000 12%
	<u>181,600,000</u>	Sub-Total	<u>259,100,000</u>
		Fixed Rate Issues	\$395,145,000 60%
		Sub-Total - Fixed	<u>395,145,000</u>
		TOTAL DEBT	
		FIXED & VAR.	<u>654,245,000</u> 100%

IRVINE RANCH WATER DISTRICT  
SUMMARY OF DEBT RATES  
Sep-20

Rmkt Agent Mode	GOLDMAN DAILY	GOLDMAN WEEKLY	GOLDMAN WEEKLY	MERRILL LYNCH DAILY	MERRILL LYNCH WEEKLY	US BANK DAILY
Bond Issue	2009 - B	2011 A-1	2011 A-2	1993	2008-A	2009-A
Par Amount	55,000,000	46,500,000	31,000,000	26,600,000	45,000,000	55,000,000
Bank	BOFA	(SIFMA -6)	(SIFMA -6)	US BANK	Sumitomo	US BANK
Reset		Wednesday	Wednesday		Wednesday	
9/1/2020	0.01%	0.03%	0.03%	0.02%	0.07%	0.02%
9/2/2020	0.01%	0.03%	0.03%	0.01%	0.07%	0.02%
9/3/2020	0.01%	0.02%	0.02%	0.01%	0.06%	0.02%
9/4/2020	0.01%	0.02%	0.02%	0.01%	0.06%	0.02%
9/5/2020	0.01%	0.02%	0.02%	0.01%	0.06%	0.02%
9/6/2020	0.01%	0.02%	0.02%	0.01%	0.06%	0.02%
9/7/2020	0.01%	0.02%	0.02%	0.01%	0.06%	0.02%
9/8/2020	0.01%	0.02%	0.02%	0.01%	0.06%	0.02%
9/9/2020	0.02%	0.02%	0.02%	0.01%	0.06%	0.02%
9/10/2020	0.06%	0.02%	0.02%	0.02%	0.07%	0.06%
9/11/2020	0.07%	0.02%	0.02%	0.12%	0.07%	0.08%
9/12/2020	0.07%	0.02%	0.02%	0.12%	0.07%	0.08%
9/13/2020	0.07%	0.02%	0.02%	0.12%	0.07%	0.08%
9/14/2020	0.11%	0.02%	0.02%	0.14%	0.07%	0.11%
9/15/2020	0.12%	0.02%	0.02%	0.14%	0.07%	0.11%
9/16/2020	0.11%	0.02%	0.02%	0.10%	0.07%	0.11%
9/17/2020	0.09%	0.06%	0.06%	0.09%	0.11%	0.10%
9/18/2020	0.08%	0.06%	0.06%	0.09%	0.11%	0.09%
9/19/2020	0.08%	0.06%	0.06%	0.09%	0.11%	0.09%
9/20/2020	0.08%	0.06%	0.06%	0.09%	0.11%	0.09%
9/21/2020	0.08%	0.06%	0.06%	0.09%	0.11%	0.08%
9/22/2020	0.08%	0.06%	0.06%	0.09%	0.11%	0.08%
9/23/2020	0.08%	0.06%	0.06%	0.09%	0.11%	0.08%
9/24/2020	0.08%	0.06%	0.06%	0.09%	0.11%	0.08%
9/25/2020	0.08%	0.06%	0.06%	0.10%	0.11%	0.09%
9/26/2020	0.08%	0.06%	0.06%	0.10%	0.11%	0.09%
9/27/2020	0.08%	0.06%	0.06%	0.10%	0.11%	0.09%
9/28/2020	0.08%	0.06%	0.06%	0.10%	0.11%	0.08%
9/29/2020	0.08%	0.06%	0.06%	0.10%	0.11%	0.08%
9/30/2020	0.09%	0.06%	0.06%	0.11%	0.11%	0.09%
Avg Interest Rates	0.06%	0.04%	0.04%	0.07%	0.09%	0.07%
Rmkt Fee	0.10%	0.13%	0.13%	0.10%	0.07%	0.07%
LOC Fee	0.30%			0.33%	0.32%	0.33%
<b>All-In Rate</b>	<b>0.46%</b>	<b>0.16%</b>	<b>0.16%</b>	<b>0.50%</b>	<b>0.47%</b>	<b>0.47%</b>
Par Amount	101,500,000		31,000,000	71,600,000		55,000,000

Interest Rate Mode	Percent of Total Variable Rate Debt	Par Outstanding	Weighted All-In Average Rate	Base Rate Average
Daily	52.72%	136,600,000	0.47%	0.07%
Weekly	47.28%	122,500,000	0.28%	0.06%
	100.00%	<b>\$ 259,100,000</b>	0.38%	0.06%
<b>Fixed</b>				
COPS 2016	29.54%	116,745,000	2.90%	
BABS 2010	44.29%	175,000,000	4.44%	(1)
SERIES 2016	26.17%	103,400,000	3.32%	
	100.00%	<b>\$ 395,145,000</b>	3.69%	
All-In Debt Rate Including \$60 Million Notional Amount of Swaps				<b>2.89%</b>

(1) Rate adjusted up from 4.35% as a result of sequestration reducing BAB's subsidy by 5.9%



Note: This page is intentionally left blank.

Exhibit "C"  
**Irvine Ranch Water District**  
**Interest Rate Swap Summary**  
**September 2020**

	Prior Mo.	Current Mo.	12-Mo Avg
LIBOR Avg %	0.16%	0.15%	0.93%

Current Fiscal Year Active Swaps								Cash Flow			(Since 3/07)	Mark to Market	
Effective Date	Maturity Date	Years to Maturity	Counter Party	Notional Amt	Type	Base Index	Fixed Rate	Prior Month	Current Month	Fiscal YTD	Cumulative Net Accrual	Current Mark to Market	Notional Difference

**Fixed Payer Swaps - By Effective Date**

3/10/2007	3/10/2029	8.4	ML	30,000,000	FXP	LIBOR	5.687%	(137,887)	(133,549)	(413,584)	(18,438,727)	16,941,820	(13,058,180)
3/10/2007	3/10/2029	8.4	CG	30,000,000	FXP	LIBOR	5.687%	(137,887)	(133,549)	(413,584)	(18,438,727)	16,931,350	(13,068,650)
Totals/Weighted Avgs		8.4		\$ 60,000,000			5.687%	\$ (275,774)	\$ (267,098)	\$ (827,168)	\$ (36,877,453)	\$ 33,873,170	\$ (26,126,830)

<b>Total Current Year Active Swaps</b>				\$ 60,000,000				\$ (275,774)	\$ (267,098)	\$ (827,168)	\$ (36,877,453)	\$ 33,873,170	\$ (26,126,830)
--	--	--	--	---------------	--	--	--	--------------	--------------	--------------	-----------------	---------------	-----------------

Current Fiscal Year Terminated Swaps								Cash Flow			Mark to Market		
Effective Date	Maturity Date		Counter Party	Notional Amt	Type	Base Index	Fixed Rate	Prior Month	Current Month	Fiscal YTD	Cumulative Net Accrual	Current Mark to Market	Notional Difference

<b>Total Current Year Terminated Swaps</b>				\$ -				\$ -	\$ -	\$ -	\$ -	\$ -	\$ -
--	--	--	--	------	--	--	--	------	------	------	------	------	------

Current Fiscal Year - Total Swaps								Cash Flow			Mark to Market		
Effective Date	Maturity Date		Counter Party	Notional Amt	Type	Base Index	Fixed Rate	Prior Month	Current Month	Fiscal YTD	Cumulative Net Accrual	Current Mark to Market	Notional Difference

<b>Total Current Year Active &amp; Terminated Swaps</b>				\$ 60,000,000				\$ (275,774)	\$ (267,098)	\$ (827,168)	\$ (36,877,453)	\$ 33,873,170	\$ (26,126,830)
---	--	--	--	---------------	--	--	--	--------------	--------------	--------------	-----------------	---------------	-----------------

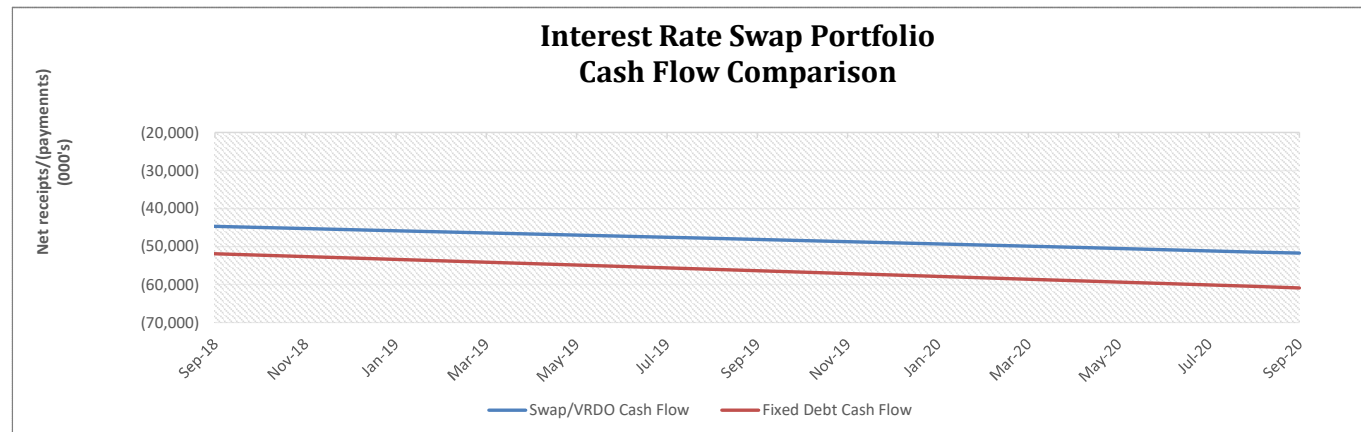

Cash Flow Comparison Synthetic Fixed vs. Fixed Rate Debt	
<u>Cash Flow to Date</u>	
Synthetic Fixed =	\$51,730,440
Fixed Rate =	\$60,852,388
<u>Assumptions:</u>	
- Fixed rate debt issued at 4.93% in Mar-07 (estimated TE rate - Bloomberg)	
- 'Synthetic' includes swap cash flow + interest + fees to date	

Note: This page is intentionally left blank.

Exhibit "D"  
 IRVINE RANCH WATER DISTRICT  
 AP DISBURSEMENTS AND VOIDS FOR SEPTEMBER 2020

CHECK OR ELECTRONIC #	SUPPLIERS	PAYMENT DATE	PAYMENT AMOUNT	PAYMENT METHOD	STATUS
411399	Bornhoff, Mike (Mike)	3-Sep-20	774.93	IRWD Check	Reconciled
411400	Breiter, Michelle	3-Sep-20	15.30	IRWD Check	Reconciled
411401	Cascelli, Craig M (Craig)	3-Sep-20	286.00	IRWD Check	Reconciled
411402	Chauv, Denise	3-Sep-20	101.00	IRWD Check	Reconciled
411403	Hufana, Mr. Eugenio D II (Gino)	3-Sep-20	152.95	IRWD Check	Reconciled
411404	Lopez, Drew	3-Sep-20	1,551.59	IRWD Check	Reconciled
411405	McElroy, Dorien	3-Sep-20	89.00	IRWD Check	Reconciled
411406	Pardee, Debra S	3-Sep-20	37.70	IRWD Check	Reconciled
411407	Weneta, John Matthew (Matt)	3-Sep-20	200.00	IRWD Check	Negotiable
411408	Zamora, Victor A	3-Sep-20	172.39	IRWD Check	Reconciled
411409	Bornhoff, Mike (Mike)	3-Sep-20	1,822.11	IRWD Check	Reconciled
411410	A&Y ASPHALT CONTRACTORS, INC.	3-Sep-20	19,233.50	IRWD Check	Reconciled
411411	AFLAC	3-Sep-20	6,745.20	IRWD Check	Reconciled
411412	AFLAC	3-Sep-20	148.76	IRWD Check	Reconciled
411413	AGILENT TECHNOLOGIES, INC.	3-Sep-20	65.79	IRWD Check	Reconciled
411414	ALSTON & BIRD LLP	3-Sep-20	12,702.81	IRWD Check	Reconciled
411415	AMAZON CAPITAL SERVICES, INC.	3-Sep-20	33.38	IRWD Check	Reconciled
411416	ANTHONY N. LARSEN	3-Sep-20	675.00	IRWD Check	Reconciled
411417	APD CONSULTANTS, INC.	3-Sep-20	19,320.00	IRWD Check	Reconciled
411418	APEX SYSTEMS, LLC	3-Sep-20	8,320.00	IRWD Check	Reconciled
411419	AQUA BEN CORPORATION	3-Sep-20	33,180.00	IRWD Check	Reconciled
411420	ARCADIS U.S., INC.	3-Sep-20	17,932.00	IRWD Check	Reconciled
411421	ASSOCIATION OF CALIFORNIA WATER AGENCIES/JPIA	3-Sep-20	38,287.37	IRWD Check	Reconciled
411422	ASSOCIATION OF CALIFORNIA WATER AGENCIES/JPIA	3-Sep-20	852.94	IRWD Check	Reconciled
411423	AT&T	3-Sep-20	498.79	IRWD Check	Reconciled
411424	AT&T	3-Sep-20	58.06	IRWD Check	Reconciled
411425	AT&T	3-Sep-20	292.36	IRWD Check	Reconciled
411426	AUTOZONE PARTS, INC.	3-Sep-20	731.66	IRWD Check	Reconciled
411427	BAVCO BACKFLOW APPARATUS & VALVE COMPANY	3-Sep-20	729.96	IRWD Check	Reconciled
411428	BILL'S SWEEPING SERVICE INC	3-Sep-20	2,288.50	IRWD Check	Reconciled
411429	BIOMAGIC INC	3-Sep-20	17,334.29	IRWD Check	Reconciled
411430	BROWN AND CALDWELL	3-Sep-20	17,206.85	IRWD Check	Reconciled
411431	BSI SERVICES AND SOLUTIONS (WEST) INC.	3-Sep-20	1,200.00	IRWD Check	Reconciled
411432	BURKE, WILLIAMS & SORENSEN, LLP	3-Sep-20	1,105.00	IRWD Check	Reconciled
411433	C WELLS PIPELINE MATERIALS INC	3-Sep-20	23,402.00	IRWD Check	Reconciled
411434	CALIFORNIA BARRICADE RENTAL, INC.	3-Sep-20	63,833.70	IRWD Check	Reconciled
411435	CHARLES P CROWLEY COMPANY INC	3-Sep-20	2,236.08	IRWD Check	Reconciled
411436	CITY OF NEWPORT BEACH	3-Sep-20	2,414.22	IRWD Check	Reconciled
411437	CITY OF ORANGE	3-Sep-20	276.00	IRWD Check	Reconciled
411438	CITY OF TUSTIN	3-Sep-20	891.08	IRWD Check	Reconciled
411439	CLARIS STRATEGY INC.	3-Sep-20	5,032.50	IRWD Check	Reconciled
411440	CLIFFORD MORIYAMA	3-Sep-20	4,000.00	IRWD Check	Reconciled
411441	COASTLINE EQUIPMENT COMPANY	3-Sep-20	2,045.59	IRWD Check	Reconciled
411442	COLONIAL LIFE & ACCIDENT INSURANCE CO.	3-Sep-20	1,103.26	IRWD Check	Reconciled
411443	CONSTELLATION NEWENERGY, INC.	3-Sep-20	10,089.44	IRWD Check	Reconciled
411444	CORELOGIC INC	3-Sep-20	0.05	IRWD Check	Reconciled
411445	COX COMMUNICATIONS, INC.	3-Sep-20	113.57	IRWD Check	Reconciled
411446	CUMMINS PACIFIC, LLC	3-Sep-20	130.37	IRWD Check	Reconciled
411447	D & H WATER SYSTEMS INC.	3-Sep-20	781.01	IRWD Check	Reconciled
411448	DC FROST ASSOCIATES, INC.	3-Sep-20	903.55	IRWD Check	Reconciled
411449	DEALERS SERVICE COMPANY, INC	3-Sep-20	4,122.86	IRWD Check	Reconciled
411450	DEMARIA ELECTRIC MOTOR SERVICES, INC.	3-Sep-20	3,682.03	IRWD Check	Reconciled
411451	DENALI WATER SOLUTIONS LLC	3-Sep-20	6,109.90	IRWD Check	Reconciled
411452	DICK R. MONOD DE FROIDEVILLE	3-Sep-20	3,587.50	IRWD Check	Reconciled
411453	DIRECTV INC	3-Sep-20	139.54	IRWD Check	Reconciled
411454	EAST ORANGE COUNTY WATER DISTRICT	3-Sep-20	2,071.30	IRWD Check	Reconciled
411455	ELITE AUTOMOTIVE SERVICE, LLC	3-Sep-20	564.15	IRWD Check	Reconciled
411456	ENVIRONMENTAL EXPRESS INC	3-Sep-20	970.90	IRWD Check	Reconciled

**IRVINE RANCH WATER DISTRICT  
AP DISBURSEMENTS AND VOIDS FOR SEPTEMBER 2020**

<b>CHECK OR ELECTRONIC #</b>	<b>SUPPLIERS</b>	<b>PAYMENT DATE</b>	<b>PAYMENT AMOUNT</b>	<b>PAYMENT METHOD</b>	<b>STATUS</b>
411457	ENVIRONMENTAL SCIENCE ASSOCIATES	3-Sep-20	165,022.07	IRWD Check	Reconciled
411458	EUROFINS CALSCIENCE, LLC	3-Sep-20	2,100.00	IRWD Check	Reconciled
411459	EXECUTIVE LIGHTING & ELECTRIC	3-Sep-20	963.27	IRWD Check	Reconciled
411460	FEDEX	3-Sep-20	477.60	IRWD Check	Reconciled
411461	FERGUSON ENTERPRISES, LLC	3-Sep-20	1,280.07	IRWD Check	Reconciled
411462	FIDELITY SECURITY LIFE INSURANCE COMPANY	3-Sep-20	791.19	IRWD Check	Reconciled
411463	FIDELITY SECURITY LIFE INSURANCE COMPANY	3-Sep-20	33.86	IRWD Check	Reconciled
411464	FIDELITY SECURITY LIFE INSURANCE COMPANY	3-Sep-20	63.78	IRWD Check	Reconciled
411465	FIDELITY SECURITY LIFE INSURANCE COMPANY	3-Sep-20	33.86	IRWD Check	Reconciled
411466	FIDELITY SECURITY LIFE INSURANCE COMPANY	3-Sep-20	6,987.63	IRWD Check	Reconciled
411467	FIRE EXTINGUISHING SAFETY & SERVICE	3-Sep-20	585.14	IRWD Check	Reconciled
411468	FISERV SOLUTIONS, LLC	3-Sep-20	22,758.26	IRWD Check	Reconciled
411469	FISHER SCIENTIFIC COMPANY LLC	3-Sep-20	3,665.50	IRWD Check	Reconciled
411470	FLEET SOLUTIONS LLC	3-Sep-20	5,772.56	IRWD Check	Reconciled
411471	FRANCHISE TAX BOARD	3-Sep-20	25.00	IRWD Check	Reconciled
411472	FUEL SOLUTIONS, INC.	3-Sep-20	5,129.00	IRWD Check	Reconciled
411473	FULLER TRUCK ACCESSORIES	3-Sep-20	1,170.17	IRWD Check	Reconciled
411474	GANAHL LUMBER CO.	3-Sep-20	423.76	IRWD Check	Reconciled
411475	GEI CONSULTANTS INC	3-Sep-20	6,120.00	IRWD Check	Reconciled
411476	GHAEMMAGHAMI, SHAMIRA	3-Sep-20	86.70	IRWD Check	Negotiable
411477	GM SAGER CONSTRUCTION CO,INC.	3-Sep-20	24,600.00	IRWD Check	Reconciled
411478	GRAINGER	3-Sep-20	3,181.10	IRWD Check	Reconciled
411479	HAAKER EQUIPMENT COMPANY	3-Sep-20	8,833.06	IRWD Check	Reconciled
411480	HACH COMPANY	3-Sep-20	4,097.10	IRWD Check	Reconciled
411481	HADI, TAMER	3-Sep-20	74.20	IRWD Check	Reconciled
411482	HANSON BRIDGETT LLP	3-Sep-20	84,046.50	IRWD Check	Reconciled
411483	HARRINGTON INDUSTRIAL PLASTICS LLC	3-Sep-20	2,286.69	IRWD Check	Reconciled
411484	HARTFORD LIFE AND ACCIDENT INSURANCE COMPANY	3-Sep-20	72.30	IRWD Check	Reconciled
411485	HDR ENGINEERING INC	3-Sep-20	8,590.68	IRWD Check	Reconciled
411486	HELPMATES STAFFING SERVICES	3-Sep-20	19,374.82	IRWD Check	Reconciled
411487	HI-LINE INC	3-Sep-20	389.91	IRWD Check	Reconciled
411488	HILL BROTHERS CHEMICAL COMPANY	3-Sep-20	11,881.92	IRWD Check	Reconciled
411489	HOME DEPOT USA INC	3-Sep-20	141.96	IRWD Check	Reconciled
411490	HUA, JUNMING	3-Sep-20	15.33	IRWD Check	Negotiable
411491	HUMANA INSURANCE COMPANY	3-Sep-20	56.60	IRWD Check	Reconciled
411492	HYDRANAUTICS	3-Sep-20	6,140.16	IRWD Check	Reconciled
411493	IDEA HALL	3-Sep-20	7,200.00	IRWD Check	Reconciled
411494	INDUSTRIAL METAL SUPPLY CO	3-Sep-20	101.06	IRWD Check	Reconciled
411495	INNOVATIVE FIRE PROTECTION, INC.	3-Sep-20	300.00	IRWD Check	Reconciled
411496	IRVINE PIPE & SUPPLY INC	3-Sep-20	2,000.69	IRWD Check	Reconciled
411497	IRVINE UNIFIED SCHOOL DISTRICT	3-Sep-20	46,104.37	IRWD Check	Reconciled
411498	IRWD-PETTY CASH CUSTODIAN	3-Sep-20	598.05	IRWD Check	Reconciled
411499	ISAAC MAHAR AND LYDIA MAHAR	3-Sep-20	71.09	IRWD Check	Reconciled
411500	J M ELECTRICAL SERVICES	3-Sep-20	3,000.00	IRWD Check	Reconciled
411501	J&A COMPANIES INC	3-Sep-20	2,664.85	IRWD Check	Reconciled
411502	JCI JONES CHEMICALS INC	3-Sep-20	4,548.57	IRWD Check	Reconciled
411503	JIG CONSULTANTS	3-Sep-20	3,075.00	IRWD Check	Negotiable
411504	JIN, CALVIN	3-Sep-20	26.79	IRWD Check	Negotiable
411505	JOHN MICHAEL COVAS	3-Sep-20	210.20	IRWD Check	Reconciled
411506	KAESER COMPRESSORS, INC.	3-Sep-20	791.00	IRWD Check	Reconciled
411507	KAN VENTURES, INC	3-Sep-20	13,000.00	IRWD Check	Reconciled
411508	KONECRANES INC	3-Sep-20	2,487.50	IRWD Check	Reconciled
411509	KROHNE, INC	3-Sep-20	403.95	IRWD Check	Reconciled
411510	KUTAK ROCK LLP	3-Sep-20	6,470.00	IRWD Check	Reconciled
411511	LA HABRA FENCE COMPANY INC	3-Sep-20	893.00	IRWD Check	Reconciled
411512	LANCER SALES USA, INC.	3-Sep-20	581.85	IRWD Check	Reconciled
411513	LANDCARE HOLDINGS, INC.	3-Sep-20	77,726.33	IRWD Check	Reconciled
411514	LEE, SCOTT	3-Sep-20	32.70	IRWD Check	Reconciled

**IRVINE RANCH WATER DISTRICT  
AP DISBURSEMENTS AND VOIDS FOR SEPTEMBER 2020**

<b>CHECK OR ELECTRONIC #</b>	<b>SUPPLIERS</b>	<b>PAYMENT DATE</b>	<b>PAYMENT AMOUNT</b>	<b>PAYMENT METHOD</b>	<b>STATUS</b>
411515	LEE, SHAWN	3-Sep-20	44.84	IRWD Check	Negotiable
411516	LINDSAY POLIC CONSULTING, INC.	3-Sep-20	6,800.00	IRWD Check	Reconciled
411517	LOPEZ, XIONEL	3-Sep-20	39.18	IRWD Check	Reconciled
411518	LOS ANGELES TIMES	3-Sep-20	308.63	IRWD Check	Reconciled
411519	MAHMOOD, DINA	3-Sep-20	22.40	IRWD Check	Reconciled
411520	MARK KADESH	3-Sep-20	10,000.00	IRWD Check	Reconciled
411521	MBK ENGINEERS	3-Sep-20	2,372.00	IRWD Check	Reconciled
411522	MC FADDEN-DALE INDUSTRIAL	3-Sep-20	45.17	IRWD Check	Reconciled
411523	MC MASTER CARR SUPPLY CO	3-Sep-20	204.27	IRWD Check	Reconciled
411524	MCR TECHNOLOGIES INC	3-Sep-20	1,715.75	IRWD Check	Reconciled
411525	MGH PAINTING INC	3-Sep-20	6,790.75	IRWD Check	Reconciled
411526	MICHAEL BAKER INTERNATIONAL, INC.	3-Sep-20	1,679.45	IRWD Check	Reconciled
411527	MSC INDUSTRIAL SUPPLY CO	3-Sep-20	536.76	IRWD Check	Reconciled
411528	MYERS & SONS HI-WAY SAFETY, INC.	3-Sep-20	2,605.40	IRWD Check	Reconciled
411529	NEWPORT REAL ESTATE SERVICES, INC.	3-Sep-20	9,591.37	IRWD Check	Reconciled
411530	NEWPORT WINDOW MAINTENANCE INC	3-Sep-20	2,385.00	IRWD Check	Reconciled
411531	NICHOLSON, KYLE	3-Sep-20	37.78	IRWD Check	Reconciled
411532	NINYO & MOORE	3-Sep-20	1,194.00	IRWD Check	Reconciled
411533	NSI LAB SOLUTIONS, INC.	3-Sep-20	311.00	IRWD Check	Reconciled
411534	OCEAN BLUE ENVIRONMENTAL SERVICES INC	3-Sep-20	5,366.80	IRWD Check	Reconciled
411535	OLIN CORPORATION	3-Sep-20	26,827.64	IRWD Check	Reconciled
411536	OLSON REMCHO LLP	3-Sep-20	925.00	IRWD Check	Reconciled
411537	ONESOURCE DISTRIBUTORS LLC	3-Sep-20	7,935.79	IRWD Check	Reconciled
411538	ORANGE COUNTY AUTO PARTS CO	3-Sep-20	4,998.78	IRWD Check	Reconciled
411539	PACIFIC PARTS & CONTROLS INC	3-Sep-20	1,054.96	IRWD Check	Reconciled
411540	PARKHOUSE TIRE INC	3-Sep-20	4,477.13	IRWD Check	Reconciled
411541	PATYI, DATTARAY	3-Sep-20	39.50	IRWD Check	Negotiable
411542	PILAR ONATE	3-Sep-20	5,000.00	IRWD Check	Reconciled
411543	PIVOT INTERIORS INC	3-Sep-20	26,871.68	IRWD Check	Reconciled
411544	PRAXAIR DISTRIBUTION INC	3-Sep-20	2,977.87	IRWD Check	Reconciled
411545	PRE-PAID LEGAL SERVICES, INC.	3-Sep-20	1,081.42	IRWD Check	Reconciled
411546	PTI SAND & GRAVEL INC	3-Sep-20	1,745.42	IRWD Check	Reconciled
411547	QIAO, TIANSHENG	3-Sep-20	54.98	IRWD Check	Reconciled
411548	QUICK CRETE PRODUCTS CORP.	3-Sep-20	1,933.04	IRWD Check	Reconciled
411549	QUINN COMPANY	3-Sep-20	3,285.24	IRWD Check	Reconciled
411550	QUINN E. EDDINS	3-Sep-20	6,609.61	IRWD Check	Reconciled
411551	RAM AIR ENGINEERING INC	3-Sep-20	1,084.00	IRWD Check	Reconciled
411552	REACH EMPLOYEE ASSISTANCE INC	3-Sep-20	1,086.40	IRWD Check	Reconciled
411553	RED WING SHOE STORE	3-Sep-20	200.00	IRWD Check	Reconciled
411554	RELIANCE STANDARD LIFE INSURANCE COMPANY	3-Sep-20	31,902.62	IRWD Check	Reconciled
411555	RHO, JOANNE	3-Sep-20	36.58	IRWD Check	Reconciled
411556	RINCON TRUCK CENTER INC.	3-Sep-20	1,511.47	IRWD Check	Reconciled
411557	RNP INC	3-Sep-20	1,352.28	IRWD Check	Reconciled
411558	SAFETY-KLEEN SYSTEMS, INC	3-Sep-20	1,641.69	IRWD Check	Reconciled
411559	SANTA MARGARITA FORD	3-Sep-20	510.71	IRWD Check	Reconciled
411560	SCALIO, ROSA	3-Sep-20	81.50	IRWD Check	Reconciled
411561	SCHINDLER ELEVATOR CORPORATION	3-Sep-20	229.11	IRWD Check	Reconciled
411562	SCHULER CONSTRUCTORS, INC.	3-Sep-20	30,135.53	IRWD Check	Reconciled
411563	SIGMA-ALDRICH INC	3-Sep-20	2,839.15	IRWD Check	Reconciled
411564	SONG, CLARA	3-Sep-20	44.25	IRWD Check	Negotiable
411565	SOUTH COAST WATER DISTRICT	3-Sep-20	1,538.94	IRWD Check	Reconciled
411566	SOUTHERN CALIFORNIA EDISON COMPANY	3-Sep-20	161.44	IRWD Check	Reconciled
411567	SOUTHERN CALIFORNIA EDISON COMPANY	3-Sep-20	485,913.86	IRWD Check	Reconciled
411568	SOUTHERN CALIFORNIA SECURITY CENTERS, INC.	3-Sep-20	19.40	IRWD Check	Reconciled
411569	SOUTHERN CALIFORNIA WATER COALITION	3-Sep-20	25,000.00	IRWD Check	Reconciled
411570	SOUTHERN CONTRACTING COMPANY	3-Sep-20	548,297.72	IRWD Check	Reconciled
411571	WATER TREATMENT CHEMICALS INC	3-Sep-20	12,093.12	IRWD Check	Reconciled
411572	TABER COMPANY, INC.	3-Sep-20	1,075.00	IRWD Check	Reconciled

**IRVINE RANCH WATER DISTRICT  
AP DISBURSEMENTS AND VOIDS FOR SEPTEMBER 2020**

<b>CHECK OR ELECTRONIC #</b>	<b>SUPPLIERS</b>	<b>PAYMENT DATE</b>	<b>PAYMENT AMOUNT</b>	<b>PAYMENT METHOD</b>	<b>STATUS</b>
411573	TANKVISIONS, INC	3-Sep-20	30.00	IRWD Check	Reconciled
411574	TETRA TECH, INC	3-Sep-20	610.00	IRWD Check	Reconciled
411575	THOMPSON INDUSTRIAL SUPPLY	3-Sep-20	3,535.28	IRWD Check	Reconciled
411576	THYSSENKRUPP ELEVATOR CORPORATION	3-Sep-20	204.73	IRWD Check	Reconciled
411577	TIAN, GUOYU	3-Sep-20	38.79	IRWD Check	Reconciled
411578	TRAN, LESLEY	3-Sep-20	33.44	IRWD Check	Negotiable
411579	TRI COUNTY PUMP COMPANY	3-Sep-20	19,877.08	IRWD Check	Reconciled
411580	TROPICAL PLAZA NURSERY INC	3-Sep-20	2,175.12	IRWD Check	Reconciled
411581	UNITED HEALTHCARE INSURANCE COMPANY	3-Sep-20	299.75	IRWD Check	Reconciled
411582	VERIZON WIRELESS SERVICES LLC	3-Sep-20	3,752.58	IRWD Check	Reconciled
411583	VERIZON WIRELESS SERVICES LLC	3-Sep-20	14,251.43	IRWD Check	Reconciled
411584	VULCAN MATERIALS COMPANY	3-Sep-20	1,489.33	IRWD Check	Reconciled
411585	WALTERS WHOLESALE ELECTRIC	3-Sep-20	2,331.42	IRWD Check	Reconciled
411586	WASTE MANAGEMENT OF CALIFORNIA, INC.	3-Sep-20	87.00	IRWD Check	Reconciled
411587	WATERLINE TECHNOLOGIES INC	3-Sep-20	3,400.00	IRWD Check	Reconciled
411588	WAXIE'S ENTERPRISES, INC	3-Sep-20	1,197.95	IRWD Check	Reconciled
411589	WECK LABORATORIES INC	3-Sep-20	4,340.00	IRWD Check	Reconciled
411590	WESTAMERICA COMMUNICATIONS, INC.	3-Sep-20	202.57	IRWD Check	Reconciled
411591	WORKPLACE SOLUTIONS LLC	3-Sep-20	3,465.24	IRWD Check	Reconciled
411592	YOON, BOKHEE	3-Sep-20	78.46	IRWD Check	Reconciled
411593	YU, CEHONG	3-Sep-20	18.80	IRWD Check	Negotiable
411594	Corey, Jo Ann K (Jo Ann)	10-Sep-20	223.01	IRWD Check	Reconciled
411595	Coria, Alejandro (Alex)	10-Sep-20	436.00	IRWD Check	Reconciled
411596	Karpan, Casey L (Casey)	10-Sep-20	60.00	IRWD Check	Reconciled
411597	Martinez, Diego	10-Sep-20	90.00	IRWD Check	Reconciled
411598	Palacio, Natalie	10-Sep-20	44.80	IRWD Check	Reconciled
411599	Rice, Tera L	10-Sep-20	2,792.86	IRWD Check	Reconciled
411600	A&Y ASPHALT CONTRACTORS, INC.	10-Sep-20	59,467.00	IRWD Check	Reconciled
411601	ABJELINA, ANGELLLI	10-Sep-20	63.61	IRWD Check	Reconciled
411602	ABSOLUTE STANDARDS, INC.	10-Sep-20	227.50	IRWD Check	Reconciled
411603	ADS LLC	10-Sep-20	2,250.00	IRWD Check	Reconciled
411604	AIR TECHNOLOGY LABORATORIES	10-Sep-20	289.00	IRWD Check	Reconciled
411605	AIRGAS, INC.	10-Sep-20	107.75	IRWD Check	Reconciled
411606	ALEXANDER'S CONTRACT SERVICES, INC.	10-Sep-20	124,122.00	IRWD Check	Reconciled
411607	ALKUS, JOSCELYNE	10-Sep-20	45.80	IRWD Check	Reconciled
411608	ANDERSON'S NU POWER CO., INC	10-Sep-20	4,945.00	IRWD Check	Reconciled
411609	APEX SYSTEMS, LLC	10-Sep-20	4,160.00	IRWD Check	Reconciled
411610	AT&T	10-Sep-20	3,616.02	IRWD Check	Reconciled
411611	AUTOZONE PARTS, INC.	10-Sep-20	1,348.58	IRWD Check	Reconciled
411612	BARTEL ASSOCIATES, LLC	10-Sep-20	1,745.00	IRWD Check	Reconciled
411613	BEST DRILLING AND PUMP, INC.	10-Sep-20	113,525.00	IRWD Check	Reconciled
411614	BIOTAGE LLC	10-Sep-20	1,035.70	IRWD Check	Reconciled
411615	BLOOMBERG FINANCE LP	10-Sep-20	13,305.00	IRWD Check	Reconciled
411616	BROOKFIELD EASTWOOD TRIPLEX LLC	10-Sep-20	413.00	IRWD Check	Negotiable
411617	C WELLS PIPELINE MATERIALS INC	10-Sep-20	7,840.44	IRWD Check	Reconciled
411618	CALIFORNIA BARRICADE RENTAL, INC.	10-Sep-20	15,289.98	IRWD Check	Reconciled
411619	CALIFORNIA DEPARTMENT OF TAX AND FEE ADMINISTRATION	10-Sep-20	544.00	IRWD Check	Reconciled
411620	CHARLES P CROWLEY COMPANY INC	10-Sep-20	743.36	IRWD Check	Reconciled
411621	CHAVEZ, KAREN	10-Sep-20	34.94	IRWD Check	Negotiable
411622	CHEM TECH INTERNATIONAL INC	10-Sep-20	14,129.82	IRWD Check	Reconciled
411623	CHO DESIGN ASSOCIATES, INC	10-Sep-20	8,400.00	IRWD Check	Reconciled
411624	CITY OF TUSTIN	10-Sep-20	158.44	IRWD Check	Reconciled
411625	CLEAN ENERGY	10-Sep-20	3,659.23	IRWD Check	Reconciled
411626	COASTLINE EQUIPMENT COMPANY	10-Sep-20	429.76	IRWD Check	Reconciled
411627	CONSTELLATION NEWENERGY, INC.	10-Sep-20	192,106.08	IRWD Check	Reconciled
411628	D & H WATER SYSTEMS INC.	10-Sep-20	781.01	IRWD Check	Reconciled
411629	DCS MANAGEMENT LLC	10-Sep-20	91.32	IRWD Check	Reconciled
411630	DE VAUL PAINT COMPANY	10-Sep-20	850.47	IRWD Check	Reconciled

**IRVINE RANCH WATER DISTRICT  
AP DISBURSEMENTS AND VOIDS FOR SEPTEMBER 2020**

<b>CHECK OR ELECTRONIC #</b>	<b>SUPPLIERS</b>	<b>PAYMENT DATE</b>	<b>PAYMENT AMOUNT</b>	<b>PAYMENT METHOD</b>	<b>STATUS</b>
411631	DEE JASPAR & ASSOCIATES, INC.	10-Sep-20	615.37	IRWD Check	Reconciled
411632	DM COLOR EXPRESS, INC.	10-Sep-20	685.29	IRWD Check	Reconciled
411633	EI&C ENGINEERING INC.	10-Sep-20	48,530.00	IRWD Check	Reconciled
411634	ELITE EQUIPMENT, INC.	10-Sep-20	684.96	IRWD Check	Reconciled
411635	EUROFINS CALSCIENCE, LLC	10-Sep-20	13,445.25	IRWD Check	Reconciled
411636	FAITHCO INC.	10-Sep-20	695.11	IRWD Check	Reconciled
411637	FASTBLUE COMMUNICATIONS INC.	10-Sep-20	1,917.00	IRWD Check	Reconciled
411638	FEDEX	10-Sep-20	91.67	IRWD Check	Reconciled
411639	FIREHOSEDIRECT.COM	10-Sep-20	632.13	IRWD Check	Reconciled
411640	FIRST CHOICE SERVICES	10-Sep-20	554.20	IRWD Check	Reconciled
411641	FISHER SCIENTIFIC COMPANY LLC	10-Sep-20	1,131.57	IRWD Check	Reconciled
411642	FOUGHT, CYNTHIA J.	10-Sep-20	2,941.05	IRWD Check	Reconciled
411643	FRANCHISE TAX BOARD	10-Sep-20	330.00	IRWD Check	Reconciled
411644	FRONTIER CALIFORNIA INC.	10-Sep-20	360.65	IRWD Check	Reconciled
411645	FUEL SOLUTIONS, INC.	10-Sep-20	12,744.98	IRWD Check	Reconciled
411646	GEI CONSULTANTS INC	10-Sep-20	4,133.00	IRWD Check	Reconciled
411647	GJ AUTOMOTIVE EQUIPMENT CO INC	10-Sep-20	946.36	IRWD Check	Reconciled
411648	GRAINGER	10-Sep-20	1,574.53	IRWD Check	Reconciled
411649	HACH COMPANY	10-Sep-20	9,188.80	IRWD Check	Reconciled
411650	HDR ENGINEERING INC	10-Sep-20	96,010.00	IRWD Check	Reconciled
411651	HELPMATES STAFFING SERVICES	10-Sep-20	8,957.77	IRWD Check	Reconciled
411652	HILL BROTHERS CHEMICAL COMPANY	10-Sep-20	1,685.00	IRWD Check	Reconciled
411653	HOME DEPOT USA INC	10-Sep-20	340.91	IRWD Check	Reconciled
411654	HOPKINS TECHNICAL PRODUCTS INC	10-Sep-20	3,125.47	IRWD Check	Reconciled
411655	iLAND INTERNET SOLUTION CORPORATION	10-Sep-20	7,482.00	IRWD Check	Reconciled
411656	INDUSTRIAL SURPLUS AND SALVAGE	10-Sep-20	5,461.46	IRWD Check	Reconciled
411657	INFOSEND, INC.	10-Sep-20	13,017.87	IRWD Check	Reconciled
411658	INTERNATIONAL BROTHERHOOD OF ELECTRICAL WORKERS LOCAL 47	10-Sep-20	2,817.06	IRWD Check	Reconciled
411659	IRVINE PIPE & SUPPLY INC	10-Sep-20	4,257.08	IRWD Check	Reconciled
411660	JCI JONES CHEMICALS INC	10-Sep-20	22,378.15	IRWD Check	Reconciled
411661	JIG CONSULTANTS	10-Sep-20	12,521.31	IRWD Check	Negotiable
411662	KAYUGA SOLUTION INC	10-Sep-20	14,840.00	IRWD Check	Reconciled
411663	KENT DAHLBERG	10-Sep-20	14,445.62	IRWD Check	Reconciled
411664	KIM, EUGENE	10-Sep-20	86.96	IRWD Check	Reconciled
411665	KOBYLARCZYK, LUCILLE J	10-Sep-20	35.11	IRWD Check	Reconciled
411666	KRONICK MOSKOVITZ TIEDEMANN & GIRARD	10-Sep-20	97,146.50	IRWD Check	Reconciled
411667	LA HABRA FENCE COMPANY INC	10-Sep-20	7,654.00	IRWD Check	Reconciled
411668	LANDCARE HOLDINGS, INC.	10-Sep-20	16,359.48	IRWD Check	Reconciled
411669	LAYTON CONSTRUCTION COMPANY, LLC	10-Sep-20	485,712.72	IRWD Check	Reconciled
411670	MARK THOMAS & COMPANY, INC.	10-Sep-20	12,438.22	IRWD Check	Reconciled
411671	MBC AQUATIC SCIENCES, INC.	10-Sep-20	1,850.00	IRWD Check	Reconciled
411672	MC MASTER CARR SUPPLY CO	10-Sep-20	200.74	IRWD Check	Reconciled
411673	MCR TECHNOLOGIES INC	10-Sep-20	567.84	IRWD Check	Reconciled
411674	MERRIMAC PETROLEUM, INC.	10-Sep-20	20,332.96	IRWD Check	Reconciled
411675	MOODY'S INVESTORS SERVICE INC	10-Sep-20	5,000.00	IRWD Check	Reconciled
411676	NATURES IMAGE INC	10-Sep-20	8,691.00	IRWD Check	Reconciled
411677	NEPTUNE TECHNOLOGY GROUP, INC.	10-Sep-20	624.95	IRWD Check	Reconciled
411678	NGUYEN, TONY	10-Sep-20	40.78	IRWD Check	Reconciled
411679	OH, DONGHYUN	10-Sep-20	52.64	IRWD Check	Negotiable
411680	OLIN CORPORATION	10-Sep-20	16,645.90	IRWD Check	Reconciled
411681	ONESOURCE DISTRIBUTORS LLC	10-Sep-20	536.97	IRWD Check	Reconciled
411682	ORANGE COUNTY AUTO PARTS CO	10-Sep-20	259.69	IRWD Check	Reconciled
411683	ORANGE LINE OIL COMPANY	10-Sep-20	2,307.92	IRWD Check	Reconciled
411684	PAPER DEPOT DOCUMENT DESTRUCTION LLC	10-Sep-20	432.00	IRWD Check	Reconciled
411685	PARKHOUSE TIRE INC	10-Sep-20	1,115.00	IRWD Check	Reconciled
411686	PENN ARCHIVE SERVICES	10-Sep-20	58.70	IRWD Check	Reconciled
411687	PERKINELMER HEALTH SCIENCES INC	10-Sep-20	16,057.98	IRWD Check	Reconciled
411688	PERS LONG TERM CARE	10-Sep-20	538.89	IRWD Check	Reconciled



**IRVINE RANCH WATER DISTRICT  
AP DISBURSEMENTS AND VOIDS FOR SEPTEMBER 2020**

<b>CHECK OR ELECTRONIC #</b>	<b>SUPPLIERS</b>	<b>PAYMENT DATE</b>	<b>PAYMENT AMOUNT</b>	<b>PAYMENT METHOD</b>	<b>STATUS</b>
411689	PILLSBURY WINTHROP SHAW PITTMAN LLP	10-Sep-20	4,377.50	IRWD Check	Reconciled
411690	PIVOT INTERIORS INC	10-Sep-20	5,178.38	IRWD Check	Reconciled
411691	PONTON INDUSTRIES INC	10-Sep-20	2,457.71	IRWD Check	Negotiable
411692	POWOJSKI, ALLISON	10-Sep-20	94.04	IRWD Check	Reconciled
411693	PROCARE WORK INJURY CENTER	10-Sep-20	1,180.00	IRWD Check	Reconciled
411694	PROFESSIONAL ELECTRICAL CONSTRUCTION SERVICES INC	10-Sep-20	1,655.43	IRWD Check	Reconciled
411695	PROTEUS CONSULTING	10-Sep-20	6,260.00	IRWD Check	Reconciled
411696	PSOMAS	10-Sep-20	7,189.00	IRWD Check	Reconciled
411697	PYRO-COMM SYSTEMS INC	10-Sep-20	920.00	IRWD Check	Reconciled
411698	QUADIENT LEASING USA, INC.	10-Sep-20	6,691.74	IRWD Check	Reconciled
411699	QUINTANA, WATTS & HARTMANN, LLC	10-Sep-20	5,000.00	IRWD Check	Negotiable
411700	RAM AIR ENGINEERING INC	10-Sep-20	4,575.00	IRWD Check	Reconciled
411701	REGENTS OF THE UNIVERSITY OF CALIFORNIA AT IRVINE	10-Sep-20	1,250.00	IRWD Check	Negotiable
411702	RINCON TRUCK CENTER INC.	10-Sep-20	459.53	IRWD Check	Reconciled
411703	SANTA ANA BLUE PRINT	10-Sep-20	891.38	IRWD Check	Reconciled
411704	SANTA MARGARITA FORD	10-Sep-20	166.39	IRWD Check	Reconciled
411705	SCOTT EQUIPMENT INCORPORATED	10-Sep-20	581.44	IRWD Check	Reconciled
411706	SCOTT FOSTER ENGINEERING, INC.	10-Sep-20	8,140.00	IRWD Check	Reconciled
411707	SECURITAS SECURITY SERVICES USA, INC.	10-Sep-20	44,231.77	IRWD Check	Reconciled
411708	SEWER PIPE SOLUTIONS LLC	10-Sep-20	2,981.36	IRWD Check	Reconciled
411709	SHAMROCK SUPPLY CO INC	10-Sep-20	36.20	IRWD Check	Reconciled
411710	SI TESTING	10-Sep-20	3,700.00	IRWD Check	Reconciled
411711	SOUTH COAST WATER CO.	10-Sep-20	95.00	IRWD Check	Reconciled
411712	SOUTH COAST WATER DISTRICT	10-Sep-20	1,028.96	IRWD Check	Reconciled
411713	SOUTHERN CALIFORNIA EDISON COMPANY	10-Sep-20	303,450.35	IRWD Check	Reconciled
411714	SOUTHERN CALIFORNIA SECURITY CENTERS, INC.	10-Sep-20	9.70	IRWD Check	Reconciled
411715	SOUTHWEST VALVE & EQUIPMENT INC	10-Sep-20	309.53	IRWD Check	Reconciled
411716	STATE WATER RESOURCES CONTROL BOARD	10-Sep-20	1,021.00	IRWD Check	Reconciled
411717	STIVERS, CHERYL	10-Sep-20	64.48	IRWD Check	Negotiable
411718	SUEZ TREATMENT SOLUTIONS INC.	10-Sep-20	1,500.92	IRWD Check	Reconciled
411719	SUKLE ADVERTISING INC.	10-Sep-20	4,512.50	IRWD Check	Reconciled
411720	THOMPSON INDUSTRIAL SUPPLY	10-Sep-20	4,789.19	IRWD Check	Reconciled
411721	THYSSENKRUPP ELEVATOR CORPORATION	10-Sep-20	204.73	IRWD Check	Reconciled
411722	TRESKA, BLAIR	10-Sep-20	131.47	IRWD Check	Reconciled
411723	TROPICAL PLAZA NURSERY INC	10-Sep-20	12,268.53	IRWD Check	Reconciled
411724	TRUCPARCO	10-Sep-20	83.10	IRWD Check	Reconciled
411725	TRUSSELL TECHNOLOGIES, INC.	10-Sep-20	1,580.00	IRWD Check	Reconciled
411726	U.S. GAIN - A DIVISION OF U.S. VENTURE, INC.	10-Sep-20	356.84	IRWD Check	Reconciled
411727	ULINE INC	10-Sep-20	2,008.34	IRWD Check	Reconciled
411728	UNDERGROUND SERVICE ALERT OF SOUTHERN CALIFORNIA	10-Sep-20	2,136.80	IRWD Check	Reconciled
411729	UNITED PARCEL SERVICE INC	10-Sep-20	124.00	IRWD Check	Reconciled
411730	UNIVAR SOLUTIONS USA INC.	10-Sep-20	4,639.72	IRWD Check	Reconciled
411731	VERIZON WIRELESS SERVICES LLC	10-Sep-20	6,979.89	IRWD Check	Reconciled
411732	VWR INTERNATIONAL, LLC	10-Sep-20	1,315.57	IRWD Check	Reconciled
411733	WALTERS WHOLESALE ELECTRIC	10-Sep-20	4,525.35	IRWD Check	Reconciled
411734	WASTE MANAGEMENT COLLECTIONS AND RECYCLING, INC.	10-Sep-20	2,963.55	IRWD Check	Reconciled
411735	WATERLINE TECHNOLOGIES INC	10-Sep-20	3,304.80	IRWD Check	Reconciled
411736	WATERSMART SOFTWARE INC	10-Sep-20	13,547.22	IRWD Check	Reconciled
411737	WECK LABORATORIES INC	10-Sep-20	7,131.20	IRWD Check	Reconciled
411738	WEISS, MATT	10-Sep-20	43.80	IRWD Check	Negotiable
411739	WEST YOST & ASSOCIATES	10-Sep-20	3,411.75	IRWD Check	Reconciled
411740	WHALEN, MARIA	10-Sep-20	13.94	IRWD Check	Negotiable
411741	YORK INSURANCE SERVICES GROUP INC - CA	10-Sep-20	8,584.25	IRWD Check	Reconciled
411742	YSI, INC	10-Sep-20	10,767.68	IRWD Check	Reconciled
411743	ZEBRON CONTRACTING INC	10-Sep-20	57,620.00	IRWD Check	Reconciled
411744	Chaney, Michael A (Michael)	17-Sep-20	3,000.00	IRWD Check	Reconciled
411745	Danielson, Gregg B (Gregg)	17-Sep-20	118.47	IRWD Check	Reconciled
411746	Mares, Michael	17-Sep-20	335.00	IRWD Check	Reconciled

**IRVINE RANCH WATER DISTRICT  
AP DISBURSEMENTS AND VOIDS FOR SEPTEMBER 2020**

<b>CHECK OR ELECTRONIC #</b>	<b>SUPPLIERS</b>	<b>PAYMENT DATE</b>	<b>PAYMENT AMOUNT</b>	<b>PAYMENT METHOD</b>	<b>STATUS</b>
411747	Rattan, Somkit (Kit)	17-Sep-20	107.72	IRWD Check	Reconciled
411748	Shapiro, Matthew	17-Sep-20	60.00	IRWD Check	Reconciled
411749	ORANGE COUNTY SANITATION DISTRICT	17-Sep-20	5,060.00	IRWD Check	Reconciled
411750	SUKLE ADVERTISING INC.	17-Sep-20	52,200.00	IRWD Check	Reconciled
411751	ADVANCED MONITORING, INC.	17-Sep-20	1,400.00	IRWD Check	Reconciled
411752	AECOM TECHNICAL SERVICES, INC.	17-Sep-20	7,372.50	IRWD Check	Reconciled
411753	AIRGAS, INC.	17-Sep-20	5,212.23	IRWD Check	Reconciled
411754	AMAZON CAPITAL SERVICES, INC.	17-Sep-20	848.49	IRWD Check	Reconciled
411755	AMERICAN WATER CHEMICALS, INC.	17-Sep-20	4,573.99	IRWD Check	Reconciled
411756	ANDERSONPENNA PARTNERS, INC.	17-Sep-20	38,488.00	IRWD Check	Reconciled
411757	APEX SYSTEMS, LLC	17-Sep-20	6,448.00	IRWD Check	Reconciled
411758	APPLIED ENGINEERING CONCEPTS	17-Sep-20	17,120.00	IRWD Check	Reconciled
411759	ASHFORD, WALT	17-Sep-20	891.78	IRWD Check	Reconciled
411760	AT&T	17-Sep-20	81.18	IRWD Check	Reconciled
411761	AT&T	17-Sep-20	5,515.39	IRWD Check	Reconciled
411762	AT&T	17-Sep-20	1,666.07	IRWD Check	Reconciled
411763	ATHENS SERVICES	17-Sep-20	7,184.92	IRWD Check	Reconciled
411764	AUTOZONE PARTS, INC.	17-Sep-20	1,773.78	IRWD Check	Reconciled
411765	BELL TOWER FLORIST & GIFTS	17-Sep-20	381.40	IRWD Check	Negotiable
411766	BIER, STEVE	17-Sep-20	1,122.70	IRWD Check	Reconciled
411767	BLACK & VEATCH CORPORATION	17-Sep-20	11,612.00	IRWD Check	Reconciled
411768	BORCHARD SURVEYING & MAPPING, INC.	17-Sep-20	3,599.50	IRWD Check	Reconciled
411769	BRENNTAG PACIFIC INC	17-Sep-20	5,675.20	IRWD Check	Reconciled
411770	C WELLS PIPELINE MATERIALS INC	17-Sep-20	13,383.64	IRWD Check	Reconciled
411771	CALIFORNIA BARRICADE RENTAL, INC.	17-Sep-20	7,567.50	IRWD Check	Reconciled
411772	CANNON CORPORATION	17-Sep-20	547.00	IRWD Check	Reconciled
411773	CANON FINANCIAL SERVICES, INC	17-Sep-20	8,343.56	IRWD Check	Reconciled
411774	CANON SOLUTIONS AMERICA, INC.	17-Sep-20	5,438.23	IRWD Check	Reconciled
411775	CAROLLO ENGINEERS, INC	17-Sep-20	18,563.50	IRWD Check	Reconciled
411776	CDW GOVERNMENT LLC	17-Sep-20	442.87	IRWD Check	Reconciled
411777	CHARLES P CROWLEY COMPANY INC	17-Sep-20	1,241.86	IRWD Check	Reconciled
411778	CLA-VAL COMPANY	17-Sep-20	9,399.56	IRWD Check	Reconciled
411779	CNC ENGINEERING	17-Sep-20	5,152.50	IRWD Check	Reconciled
411780	CONSTELLATION NEWENERGY, INC.	17-Sep-20	49,185.41	IRWD Check	Reconciled
411781	COX COMMUNICATIONS, INC.	17-Sep-20	270.77	IRWD Check	Reconciled
411782	CR & R INCORPORATED	17-Sep-20	428.34	IRWD Check	Reconciled
411783	CULLIGAN OF SANTA ANA	17-Sep-20	21,000.00	IRWD Check	Reconciled
411784	D & G SIGNS	17-Sep-20	367.44	IRWD Check	Reconciled
411785	DANG, VUONG	17-Sep-20	189.88	IRWD Check	Reconciled
411786	DCS MANAGEMENT LLC	17-Sep-20	64.29	IRWD Check	Reconciled
411787	DEAVER SPRING INC	17-Sep-20	721.46	IRWD Check	Reconciled
411788	DELL MARKETING LP	17-Sep-20	8,820.54	IRWD Check	Reconciled
411789	DEX MEDIA, INC.	17-Sep-20	41.00	IRWD Check	Reconciled
411790	DG INVESTMENT INTERMEDIATE HOLDINGS 2, INC.	17-Sep-20	3,999.78	IRWD Check	Reconciled
411791	DMC ENGINEERING INC	17-Sep-20	6,027.18	IRWD Check	Reconciled
411792	DRAEGER, INC.	17-Sep-20	6,457.30	IRWD Check	Reconciled
411793	ENVIRONMENTAL ENGINEERING AND CONTRACTING, INC.	17-Sep-20	11,620.00	IRWD Check	Reconciled
411794	ENVIRONMENTAL RESOURCE ASSOCIATES	17-Sep-20	570.40	IRWD Check	Reconciled
411795	EVERETT DOREY LLP	17-Sep-20	13,401.11	IRWD Check	Reconciled
411796	EXECUTIVE LIGHTING & ELECTRIC	17-Sep-20	190.00	IRWD Check	Reconciled
411797	FEDEX	17-Sep-20	260.63	IRWD Check	Reconciled
411798	FERGUSON ENTERPRISES, LLC	17-Sep-20	16,636.95	IRWD Check	Reconciled
411799	FERREIRA CONSTRUCTION COMPANY, INC.	17-Sep-20	25,124.88	IRWD Check	Reconciled
411800	FIONA HUTTON & ASSOCIATES, INC.	17-Sep-20	9,570.00	IRWD Check	Reconciled
411801	FISHER SCIENTIFIC COMPANY LLC	17-Sep-20	7,247.32	IRWD Check	Reconciled
411802	FRONTIER CALIFORNIA INC.	17-Sep-20	57.31	IRWD Check	Reconciled
411803	GEI CONSULTANTS INC	17-Sep-20	960.00	IRWD Check	Reconciled
411804	GI ENDURANT LLC	17-Sep-20	8,931.00	IRWD Check	Reconciled

**IRVINE RANCH WATER DISTRICT  
AP DISBURSEMENTS AND VOIDS FOR SEPTEMBER 2020**

<b>CHECK OR ELECTRONIC #</b>	<b>SUPPLIERS</b>	<b>PAYMENT DATE</b>	<b>PAYMENT AMOUNT</b>	<b>PAYMENT METHOD</b>	<b>STATUS</b>
411805	GRAINGER	17-Sep-20	2,724.64	IRWD Check	Reconciled
411806	GRAYBAR ELECTRIC COMPANY	17-Sep-20	224.18	IRWD Check	Reconciled
411807	HARPER & ASSOCIATES ENGINEERING INC	17-Sep-20	4,200.00	IRWD Check	Negotiable
411808	HARRINGTON INDUSTRIAL PLASTICS LLC	17-Sep-20	20,838.76	IRWD Check	Reconciled
411809	HDR ENGINEERING INC	17-Sep-20	73,908.96	IRWD Check	Reconciled
411810	HELPMATES STAFFING SERVICES	17-Sep-20	11,857.06	IRWD Check	Reconciled
411811	HEUERMAN, DALE	17-Sep-20	283.29	IRWD Check	Negotiable
411812	HI-LINE INC	17-Sep-20	459.65	IRWD Check	Reconciled
411813	HILL BROTHERS CHEMICAL COMPANY	17-Sep-20	15,291.18	IRWD Check	Negotiable
411814	HOME DEPOT USA INC	17-Sep-20	1,376.28	IRWD Check	Reconciled
411815	ICP DAS USA INC	17-Sep-20	1,298.00	IRWD Check	Reconciled
411816	IMPERIAL SPRINKLER SUPPLY, INC.	17-Sep-20	121.49	IRWD Check	Reconciled
411817	INDUSTRIAL METAL SUPPLY CO	17-Sep-20	12.51	IRWD Check	Negotiable
411818	INFOSYS LIMITED	17-Sep-20	26,880.00	IRWD Check	Reconciled
411819	INTEGRITY MUNICIPAL SERVICES LLC	17-Sep-20	2,500.00	IRWD Check	Reconciled
411820	INTRINSIC SAFETY EQUIPMENT OF TEXAS, INC.	17-Sep-20	3,367.74	IRWD Check	Reconciled
411821	IRON MOUNTAIN INFORMATION MANAGEMENT INC	17-Sep-20	2,081.69	IRWD Check	Reconciled
411822	IRVINE PIPE & SUPPLY INC	17-Sep-20	3,253.44	IRWD Check	Reconciled
411823	JAMES BRADFORD HALDEMAN	17-Sep-20	3,800.00	IRWD Check	Reconciled
411824	JIG CONSULTANTS	17-Sep-20	3,540.00	IRWD Check	Negotiable
411825	JOSLIN, JOHN	17-Sep-20	272.04	IRWD Check	Negotiable
411826	KONECRANES INC	17-Sep-20	6,700.00	IRWD Check	Reconciled
411827	LAGUNA BEACH COUNTY WATER DISTRICT	17-Sep-20	4,158.79	IRWD Check	Reconciled
411828	LALITA & RISHI GUPTA	17-Sep-20	406.67	IRWD Check	Negotiable
411829	LANDCARE HOLDINGS, INC.	17-Sep-20	4,392.60	IRWD Check	Reconciled
411830	LCS TECHNOLOGIES, INC.	17-Sep-20	10,125.00	IRWD Check	Negotiable
411831	LEADERSHIP TOMORROW	17-Sep-20	3,000.00	IRWD Check	Reconciled
411832	LIFECOM, INC.	17-Sep-20	287.61	IRWD Check	Reconciled
411833	LSA ASSOCIATES INC	17-Sep-20	7,421.31	IRWD Check	Reconciled
411834	LU'S LIGHTHOUSE, INC.	17-Sep-20	1,486.80	IRWD Check	Reconciled
411835	LUBRICATION ENGINEERS, INC.	17-Sep-20	1,565.70	IRWD Check	Reconciled
411836	LUU, RICKY	17-Sep-20	110.98	IRWD Check	Reconciled
411837	MAP COMMUNICATIONS, INC.	17-Sep-20	3,062.58	IRWD Check	Negotiable
411838	MC FADDEN-DALE INDUSTRIAL	17-Sep-20	146.29	IRWD Check	Reconciled
411839	MERCURY INSURANCE AS SUBROGEE FOR MYUNG YI	17-Sep-20	8,511.82	IRWD Check	Reconciled
411840	MICROSOFT CORPORATION	17-Sep-20	829.86	IRWD Check	Reconciled
411841	MRO ELECTRIC & SUPPLY CO.	17-Sep-20	8,452.00	IRWD Check	Reconciled
411842	MUNICIPAL MAINTENANCE EQUIPMENT INC	17-Sep-20	110.36	IRWD Check	Reconciled
411843	NATIONAL READY MIXED CONCRETE SALES, LLC	17-Sep-20	1,217.19	IRWD Check	Reconciled
411844	NATURALWELL, LLC	17-Sep-20	2,392.50	IRWD Check	Reconciled
411845	NIXON-EGLI EQUIPMENT COMPANY INC.	17-Sep-20	3,190.99	IRWD Check	Reconciled
411846	NMG GEOTECHNICAL INC	17-Sep-20	5,517.00	IRWD Check	Reconciled
411847	O.C. SUPERIOR CUSTOM CLEANING	17-Sep-20	3,600.00	IRWD Check	Reconciled
411848	OLIN CORPORATION	17-Sep-20	23,279.91	IRWD Check	Reconciled
411849	ORACLE AMERICA, INC.	17-Sep-20	195,743.50	IRWD Check	Reconciled
411850	ORANGE COAST PLUMBING	17-Sep-20	175.00	IRWD Check	Reconciled
411851	ORANGE COUNTY AUTO PARTS CO	17-Sep-20	3,523.72	IRWD Check	Reconciled
411852	ORANGE COUNTY MOSQUITO AND VECTOR CONTROL DISTRICT	17-Sep-20	6,431.64	IRWD Check	Negotiable
411853	PACIFIC HYDROTECH CORPORATION	17-Sep-20	14,651.74	IRWD Check	Reconciled
411854	PACIFIC HYDROTECH CORPORATION	17-Sep-20	28,180.22	IRWD Check	Reconciled
411855	PACIFIC HYDROTECH CORPORATION	17-Sep-20	813,807.34	IRWD Check	Reconciled
411856	PACIFIC PARTS & CONTROLS INC	17-Sep-20	2,415.22	IRWD Check	Reconciled
411857	PARKHOUSE TIRE INC	17-Sep-20	5,030.43	IRWD Check	Reconciled
411858	PARKWAY LAWNMOWER SHOP	17-Sep-20	386.74	IRWD Check	Reconciled
411859	PIVOT INTERIORS INC	17-Sep-20	20,493.56	IRWD Check	Reconciled
411860	PRAXAIR DISTRIBUTION INC	17-Sep-20	2,783.21	IRWD Check	Reconciled
411861	PROCARE WORK INJURY CENTER	17-Sep-20	9,800.00	IRWD Check	Reconciled
411862	PRUDENTIAL OVERALL SUPPLY	17-Sep-20	6,792.57	IRWD Check	Reconciled

**IRVINE RANCH WATER DISTRICT  
AP DISBURSEMENTS AND VOIDS FOR SEPTEMBER 2020**

<b>CHECK OR ELECTRONIC #</b>	<b>SUPPLIERS</b>	<b>PAYMENT DATE</b>	<b>PAYMENT AMOUNT</b>	<b>PAYMENT METHOD</b>	<b>STATUS</b>
411863	RAM AIR ENGINEERING INC	17-Sep-20	1,098.23	IRWD Check	Reconciled
411864	RLG ENTERPRISES, INC	17-Sep-20	591.35	IRWD Check	Reconciled
411865	SAFETY CENTER INCORPORATED	17-Sep-20	1,848.00	IRWD Check	Reconciled
411866	SANTA MARGARITA FORD	17-Sep-20	66.16	IRWD Check	Reconciled
411867	SECURITAS SECURITY SERVICES USA, INC.	17-Sep-20	37,377.29	IRWD Check	Reconciled
411868	SEDONA COMMUNITY ASSN	17-Sep-20	1,136.16	IRWD Check	Reconciled
411869	SERRANO WATER DISTRICT	17-Sep-20	15,946.37	IRWD Check	Reconciled
411870	SHAMROCK SUPPLY CO INC	17-Sep-20	1,818.87	IRWD Check	Reconciled
411871	SOUTH BAY FOUNDRY, INC	17-Sep-20	6,060.94	IRWD Check	Reconciled
411872	SOUTH COAST AIR QUALITY MANAGEMENT DISTRICT	17-Sep-20	37,347.86	IRWD Check	Reconciled
411873	SOUTHERN CALIFORNIA EDISON COMPANY	17-Sep-20	37,089.26	IRWD Check	Reconciled
411874	SOUTHERN CALIFORNIA GAS COMPANY	17-Sep-20	9,406.52	IRWD Check	Reconciled
411875	SOUTHERN CALIFORNIA SECURITY CENTERS, INC.	17-Sep-20	139.00	IRWD Check	Negotiable
411876	SPARKLETTES	17-Sep-20	71.93	IRWD Check	Negotiable
411877	SPARLING INSTRUMENTS LLC	17-Sep-20	248.71	IRWD Check	Reconciled
411878	STETSON ENGINEERS INC.	17-Sep-20	1,217.50	IRWD Check	Negotiable
411879	STREAKWAVE WIRELESS, INC.	17-Sep-20	245.08	IRWD Check	Reconciled
411880	SUKLE ADVERTISING INC.	17-Sep-20	73,580.19	IRWD Check	Negotiable
411881	SULZER ELECTRO-MECHANICAL SERVICES (US) INC.	17-Sep-20	6,099.73	IRWD Check	Reconciled
411882	SUNSHINE SUPPLY COMPANY, INC.	17-Sep-20	3,418.37	IRWD Check	Reconciled
411883	SUSAN A. SIROTA	17-Sep-20	4,660.00	IRWD Check	Reconciled
411884	SWAINS ELECTRIC MOTOR SERVICE	17-Sep-20	19,473.06	IRWD Check	Reconciled
411885	TETRA TECH, INC	17-Sep-20	7,493.50	IRWD Check	Reconciled
411886	TEVORA BUSINESS SOLUTIONS, INC.	17-Sep-20	6,048.33	IRWD Check	Reconciled
411887	THOMPSON INDUSTRIAL SUPPLY	17-Sep-20	1,073.06	IRWD Check	Reconciled
411888	TIGHT QUARTERS INC.	17-Sep-20	6,700.00	IRWD Check	Reconciled
411889	TREE OF LIFE NURSERY	17-Sep-20	696.82	IRWD Check	Negotiable
411890	TRI COUNTY PUMP COMPANY	17-Sep-20	18,192.00	IRWD Check	Reconciled
411891	TROPICAL PLAZA NURSERY INC	17-Sep-20	21,351.89	IRWD Check	Reconciled
411892	TRUCPARCO	17-Sep-20	567.48	IRWD Check	Reconciled
411893	UNITED SITE SERVICES OF CALIFORNIA INC	17-Sep-20	835.67	IRWD Check	Reconciled
411894	UNIVAR SOLUTIONS USA INC.	17-Sep-20	4,697.90	IRWD Check	Reconciled
411895	USA WASTE OF CALIFORNIA, INC.	17-Sep-20	465.00	IRWD Check	Negotiable
411896	VAUGHAN'S INDUSTRIAL REPAIR CO INC	17-Sep-20	7,677.40	IRWD Check	Reconciled
411897	VULCAN MATERIALS COMPANY	17-Sep-20	1,560.05	IRWD Check	Reconciled
411898	VWR INTERNATIONAL, LLC	17-Sep-20	97.05	IRWD Check	Reconciled
411899	WASTE MANAGEMENT COLLECTIONS AND RECYCLING, INC.	17-Sep-20	2,795.09	IRWD Check	Reconciled
411900	WATER MANAGEMENT GROUP	17-Sep-20	930.00	IRWD Check	Reconciled
411901	WAXIE'S ENTERPRISES, INC	17-Sep-20	2,035.34	IRWD Check	Reconciled
411902	WIRELESS WATCHDOGS, LLC	17-Sep-20	1,640.00	IRWD Check	Reconciled
411903	WORKFORCE SAFETY LLC	17-Sep-20	3,000.00	IRWD Check	Negotiable
411904	YSI, INC	17-Sep-20	34,021.58	IRWD Check	Reconciled
411905	ZIMA CORPORATION	17-Sep-20	660.02	IRWD Check	Reconciled
411906	Cortez, Brian	24-Sep-20	1,086.11	IRWD Check	Reconciled
411907	Garcia, Alejandro (Alex)	24-Sep-20	592.00	IRWD Check	Reconciled
411908	Hall, William P (William)	24-Sep-20	1,379.06	IRWD Check	Reconciled
411909	Sanchez, Fiona M (Fiona)	24-Sep-20	17.22	IRWD Check	Negotiable
411910	Schreiner, Terrance M Jr (Terrance)	24-Sep-20	298.00	IRWD Check	Reconciled
411911	GRAINGER	24-Sep-20	2,642.14	IRWD Check	Reconciled
411912	A&Y ASPHALT CONTRACTORS, INC.	24-Sep-20	2,760.00	IRWD Check	Reconciled
411913	AAF INTERNATIONAL	24-Sep-20	1,546.87	IRWD Check	Reconciled
411914	ABM INDUSTRY GROUPS, LLC	24-Sep-20	6,124.67	IRWD Check	Reconciled
411915	ADOBE INC.	24-Sep-20	5,401.60	IRWD Check	Reconciled
411916	ALLIANT INSURANCE SERVICES, INC	24-Sep-20	10,989.29	IRWD Check	Reconciled
411917	AMAZON CAPITAL SERVICES, INC.	24-Sep-20	6,215.50	IRWD Check	Reconciled
411918	AMERICAN WATER CHEMICALS, INC.	24-Sep-20	5,112.74	IRWD Check	Reconciled
411919	AMETEK BROOKFIELD	24-Sep-20	2,135.38	IRWD Check	Reconciled
411920	APEX SYSTEMS, LLC	24-Sep-20	16,224.00	IRWD Check	Reconciled

**IRVINE RANCH WATER DISTRICT  
AP DISBURSEMENTS AND VOIDS FOR SEPTEMBER 2020**

<b>CHECK OR ELECTRONIC #</b>	<b>SUPPLIERS</b>	<b>PAYMENT DATE</b>	<b>PAYMENT AMOUNT</b>	<b>PAYMENT METHOD</b>	<b>STATUS</b>
411921	ARBEZU, SIMITRIA	24-Sep-20	13.72	IRWD Check	Negotiable
411922	ARCADIS U.S., INC.	24-Sep-20	1,375.00	IRWD Check	Reconciled
411923	AT&T	24-Sep-20	8,171.64	IRWD Check	Reconciled
411924	AT&T	24-Sep-20	174.59	IRWD Check	Reconciled
411925	ATHENS SERVICES	24-Sep-20	1,851.36	IRWD Check	Reconciled
411926	AUTOZONE PARTS, INC.	24-Sep-20	988.73	IRWD Check	Negotiable
411927	BALADHANDAYUTHAM, SIVAGURUNA	24-Sep-20	1,294.36	IRWD Check	Negotiable
411928	BENCHMARK CRANE	24-Sep-20	1,000.00	IRWD Check	Negotiable
411929	BEST BUY BUSINESS ADVANTAGE ACCOUNT	24-Sep-20	869.04	IRWD Check	Reconciled
411930	BIGWIG MONSTER, LLC	24-Sep-20	3,000.00	IRWD Check	Negotiable
411931	BIOMAGIC INC	24-Sep-20	16,035.79	IRWD Check	Negotiable
411932	BIOQUIP PRODUCTS INC	24-Sep-20	4,994.05	IRWD Check	Reconciled
411933	BLACK & VEATCH CORPORATION	24-Sep-20	455,758.30	IRWD Check	Reconciled
411934	BOYD & ASSOCIATES	24-Sep-20	3,602.00	IRWD Check	Reconciled
411935	BUSHMAN, BRENT	24-Sep-20	64.92	IRWD Check	Negotiable
411936	C WELLS PIPELINE MATERIALS INC	24-Sep-20	7,940.43	IRWD Check	Reconciled
411937	C. L. OLSON & ASSOCIATES, INC.	24-Sep-20	3,038.55	IRWD Check	Reconciled
411938	CALIFORNIA BARRICADE RENTAL, INC.	24-Sep-20	13,953.99	IRWD Check	Reconciled
411939	CALLAHAN, KYLEE	24-Sep-20	56.93	IRWD Check	Negotiable
411940	CARMELL, GARY	24-Sep-20	87.15	IRWD Check	Reconciled
411941	CAROLLO ENGINEERS, INC	24-Sep-20	50,469.75	IRWD Check	Reconciled
411942	CHEM TECH INTERNATIONAL INC	24-Sep-20	41,617.57	IRWD Check	Reconciled
411943	CHEN, YANG	24-Sep-20	2,186.25	IRWD Check	Negotiable
411944	CHOI, RICHARD	24-Sep-20	41.62	IRWD Check	Reconciled
411945	CITY OF IRVINE	24-Sep-20	5,739.30	IRWD Check	Reconciled
411946	CITY OF NEWPORT BEACH	24-Sep-20	1,909.33	IRWD Check	Negotiable
411947	CITY OF SANTA ANA	24-Sep-20	295.03	IRWD Check	Reconciled
411948	CLA-VAL COMPANY	24-Sep-20	5,658.69	IRWD Check	Reconciled
411949	COASTLINE EQUIPMENT COMPANY	24-Sep-20	4,171.49	IRWD Check	Reconciled
411950	CONSTELLATION NEWENERGY, INC.	24-Sep-20	31,689.82	IRWD Check	Negotiable
411951	COX COMMUNICATIONS, INC.	24-Sep-20	3,755.21	IRWD Check	Reconciled
411952	CRESCENT CHEMICAL CO.	24-Sep-20	410.28	IRWD Check	Reconciled
411953	CRUZ, CESAR	24-Sep-20	38.99	IRWD Check	Negotiable
411954	D & G SIGNS	24-Sep-20	6,982.20	IRWD Check	Reconciled
411955	D & H WATER SYSTEMS INC.	24-Sep-20	5,633.54	IRWD Check	Reconciled
411956	DEE JASPAR & ASSOCIATES, INC.	24-Sep-20	784.60	IRWD Check	Reconciled
411957	DIRECTV INC	24-Sep-20	145.99	IRWD Check	Negotiable
411958	DM COLOR EXPRESS, INC.	24-Sep-20	241.90	IRWD Check	Reconciled
411959	ENDRESS AND HAUSER INC	24-Sep-20	20,001.63	IRWD Check	Reconciled
411960	ENVIRONMENTAL EQUIPMENT SUPPLY	24-Sep-20	425.24	IRWD Check	Reconciled
411961	ENVIRONMENTAL RESOURCE ASSOCIATES	24-Sep-20	1,184.23	IRWD Check	Reconciled
411962	ENVIRONMENTAL SCIENCE ASSOCIATES	24-Sep-20	64,555.56	IRWD Check	Reconciled
411963	EUROFINS CALSCIENCE, LLC	24-Sep-20	1,638.00	IRWD Check	Reconciled
411964	FARRELL & ASSOCIATES	24-Sep-20	241.43	IRWD Check	Reconciled
411965	FERGUSON ENTERPRISES, LLC	24-Sep-20	2,639.88	IRWD Check	Reconciled
411966	FERGUSON ENTERPRISES, LLC	24-Sep-20	5,409.05	IRWD Check	Reconciled
411967	FISHER SCIENTIFIC COMPANY LLC	24-Sep-20	5,619.95	IRWD Check	Reconciled
411968	FRANCHISE TAX BOARD	24-Sep-20	330.00	IRWD Check	Negotiable
411969	FRONTIER CALIFORNIA INC.	24-Sep-20	620.77	IRWD Check	Reconciled
411970	GANAHL LUMBER CO.	24-Sep-20	344.24	IRWD Check	Negotiable
411971	GEORGE HILLS COMPANY, INC.	24-Sep-20	1,907.00	IRWD Check	Negotiable
411972	GRAINGER	24-Sep-20	11,592.29	IRWD Check	Reconciled
411973	HAAKER EQUIPMENT COMPANY	24-Sep-20	485.69	IRWD Check	Reconciled
411974	HACH COMPANY	24-Sep-20	5,365.96	IRWD Check	Reconciled
411975	HAMILTON, KURT	24-Sep-20	1,846.76	IRWD Check	Negotiable
411976	HANNA INSTRUMENTS UNITED STATES, INC	24-Sep-20	177.98	IRWD Check	Negotiable
411977	HARRINGTON INDUSTRIAL PLASTICS LLC	24-Sep-20	217.73	IRWD Check	Reconciled
411978	HELPMATES STAFFING SERVICES	24-Sep-20	15,364.12	IRWD Check	Reconciled

**IRVINE RANCH WATER DISTRICT  
AP DISBURSEMENTS AND VOIDS FOR SEPTEMBER 2020**

<b>CHECK OR ELECTRONIC #</b>	<b>SUPPLIERS</b>	<b>PAYMENT DATE</b>	<b>PAYMENT AMOUNT</b>	<b>PAYMENT METHOD</b>	<b>STATUS</b>
411979	HENNING, JUDITH	24-Sep-20	189.58	IRWD Check	Negotiable
411980	HI-LINE INC	24-Sep-20	48.84	IRWD Check	Reconciled
411981	HILL BROTHERS CHEMICAL COMPANY	24-Sep-20	2,194.29	IRWD Check	Negotiable
411982	HINSILBLON LTD	24-Sep-20	25,534.00	IRWD Check	Negotiable
411983	HOME DEPOT USA INC	24-Sep-20	976.28	IRWD Check	Reconciled
411984	IDEXX DISTRIBUTION, INC	24-Sep-20	1,871.99	IRWD Check	Reconciled
411985	INDUSTRIAL METAL SUPPLY CO	24-Sep-20	606.82	IRWD Check	Reconciled
411986	INFOSEND, INC.	24-Sep-20	32,582.46	IRWD Check	Reconciled
411987	INTERNATIONAL BROTHERHOOD OF ELECTRICAL WORKERS LOCAL 47	24-Sep-20	2,835.71	IRWD Check	Negotiable
411988	IRVINE PIPE & SUPPLY INC	24-Sep-20	4,485.78	IRWD Check	Reconciled
411989	JACOBS ENGINEERING GROUP INC.	24-Sep-20	36,520.58	IRWD Check	Reconciled
411990	JAMES BRADFORD HALDEMAN	24-Sep-20	4,500.00	IRWD Check	Negotiable
411991	JENNINGS, MARIA	24-Sep-20	368.66	IRWD Check	Reconciled
411992	JUST ENERGY SOLUTIONS INC.	24-Sep-20	1,878.77	IRWD Check	Reconciled
411993	KENT DAHLBERG	24-Sep-20	13,258.93	IRWD Check	Negotiable
411994	KEY INFORMATION SYSTEMS, INC.	24-Sep-20	2,050.00	IRWD Check	Reconciled
411995	KUTAK ROCK LLP	24-Sep-20	14,313.03	IRWD Check	Reconciled
411996	LANDCARE HOLDINGS, INC.	24-Sep-20	12,882.75	IRWD Check	Reconciled
411997	LEE & RO, INC.	24-Sep-20	25,861.64	IRWD Check	Reconciled
411998	LINKEDIN CORPORATION	24-Sep-20	14,525.00	IRWD Check	Reconciled
411999	LUO, YUANYUAN	24-Sep-20	33.89	IRWD Check	Negotiable
412000	MBK ENGINEERS	24-Sep-20	12,866.00	IRWD Check	Reconciled
412001	MC MASTER CARR SUPPLY CO	24-Sep-20	1,181.23	IRWD Check	Reconciled
412002	MUTUAL PROPANE	24-Sep-20	230.58	IRWD Check	Reconciled
412003	NATIONAL READY MIXED CONCRETE SALES, LLC	24-Sep-20	2,001.88	IRWD Check	Reconciled
412004	NRD, LLC	24-Sep-20	100.00	IRWD Check	Reconciled
412005	OCTA	24-Sep-20	2,609.00	IRWD Check	Negotiable
412006	OLIN CORPORATION	24-Sep-20	23,453.88	IRWD Check	Reconciled
412007	ORANGE COUNTY FIRE PROTECTION	24-Sep-20	430.00	IRWD Check	Reconciled
412008	ORANGE COUNTY SHERIFF'S OFFICE	24-Sep-20	530.37	IRWD Check	Negotiable
412009	ORANGE LINE OIL COMPANY	24-Sep-20	2,513.22	IRWD Check	Reconciled
412010	OUTDOOR DIMENSIONS, LLC	24-Sep-20	24,545.07	IRWD Check	Reconciled
412011	PACIFIC COAST BOLT CORP	24-Sep-20	1,287.41	IRWD Check	Reconciled
412012	PACIFIC PARTS & CONTROLS INC	24-Sep-20	626.12	IRWD Check	Reconciled
412013	PARADA PAINTING INC	24-Sep-20	2,500.00	IRWD Check	Negotiable
412014	PARKHOUSE TIRE INC	24-Sep-20	533.04	IRWD Check	Reconciled
412015	PARKWAY LAWNMOWER SHOP	24-Sep-20	4,780.89	IRWD Check	Negotiable
412016	PARMA	24-Sep-20	150.00	IRWD Check	Reconciled
412017	PATTEN SYSTEMS, INC.	24-Sep-20	5,066.33	IRWD Check	Reconciled
412018	PAULUS ENGINEERING, INC.	24-Sep-20	114,042.42	IRWD Check	Reconciled
412019	PERS LONG TERM CARE	24-Sep-20	538.89	IRWD Check	Reconciled
412020	PESTGON, INC.	24-Sep-20	450.00	IRWD Check	Reconciled
412021	PINNACLE TOWERS LLC	24-Sep-20	779.18	IRWD Check	Reconciled
412022	PLUMBERS DEPOT INC.	24-Sep-20	1,341.49	IRWD Check	Reconciled
412023	PRAXAIR DISTRIBUTION INC	24-Sep-20	249.86	IRWD Check	Reconciled
412024	PRUDENTIAL OVERALL SUPPLY	24-Sep-20	7,473.70	IRWD Check	Reconciled
412025	PTI SAND & GRAVEL INC	24-Sep-20	1,269.77	IRWD Check	Reconciled
412026	RAM AIR ENGINEERING INC	24-Sep-20	765.00	IRWD Check	Reconciled
412027	REFRIGERATION SUPPLIES DISTRIBUTOR	24-Sep-20	406.23	IRWD Check	Reconciled
412028	REGENTS OF THE UNIVERSITY OF CALIFORNIA AT IRVINE	24-Sep-20	2,250.00	IRWD Check	Negotiable
412029	RENTOKIL NORTH AMERICA, INC	24-Sep-20	5,756.00	IRWD Check	Reconciled
412030	RESTEK CORPORATION	24-Sep-20	304.41	IRWD Check	Reconciled
412031	ROBLES, MARIBEL	24-Sep-20	21.19	IRWD Check	Negotiable
412032	SANTA ANA BLUE PRINT	24-Sep-20	138.27	IRWD Check	Negotiable
412033	SCHULER CONSTRUCTORS, INC.	24-Sep-20	13,164.30	IRWD Check	Reconciled
412034	SHAMROCK SUPPLY CO INC	24-Sep-20	845.25	IRWD Check	Reconciled
412035	SITEONE LANDSCAPE SUPPLY, LLC	24-Sep-20	56.57	IRWD Check	Reconciled
412036	SOUTHERN CALIFORNIA EDISON COMPANY	24-Sep-20	510,364.82	IRWD Check	Reconciled

**IRVINE RANCH WATER DISTRICT  
AP DISBURSEMENTS AND VOIDS FOR SEPTEMBER 2020**

<b>CHECK OR ELECTRONIC #</b>	<b>SUPPLIERS</b>	<b>PAYMENT DATE</b>	<b>PAYMENT AMOUNT</b>	<b>PAYMENT METHOD</b>	<b>STATUS</b>
412037	SOUTHERN CALIFORNIA EDISON COMPANY	24-Sep-20	61.60	IRWD Check	Negotiable
412038	SOUTHERN CALIFORNIA EDISON COMPANY	24-Sep-20	732.02	IRWD Check	Negotiable
412039	SOUTHERN CALIFORNIA GAS COMPANY	24-Sep-20	597.29	IRWD Check	Reconciled
412040	SOUTHERN COUNTIES LUBRICANTS LLC	24-Sep-20	3,171.87	IRWD Check	Reconciled
412041	SOUTHWESTERN TECHNICAL MARKETING COMPANY, INC	24-Sep-20	1,954.63	IRWD Check	Negotiable
412042	SPARKLETTS	24-Sep-20	164.98	IRWD Check	Negotiable
412043	STANTEC CONSULTING SERVICES INC.	24-Sep-20	2,100.00	IRWD Check	Reconciled
412044	STREAKWAVE WIRELESS, INC.	24-Sep-20	1,763.84	IRWD Check	Reconciled
412045	SUEZ TREATMENT SOLUTIONS INC.	24-Sep-20	5,393.18	IRWD Check	Reconciled
412046	SUKLE ADVERTISING INC.	24-Sep-20	61,321.50	IRWD Check	Negotiable
412047	TEKDRAULICS	24-Sep-20	3,477.38	IRWD Check	Negotiable
412048	TENNEY, JON	24-Sep-20	121.33	IRWD Check	Negotiable
412049	TETRA TECH, INC	24-Sep-20	20,602.00	IRWD Check	Reconciled
412050	THE SHERWIN WILLIAMS COMPANY	24-Sep-20	890.45	IRWD Check	Reconciled
412051	TORAY MEMBRANE USA, INC.	24-Sep-20	104,208.00	IRWD Check	Reconciled
412052	TROPICAL PLAZA NURSERY INC	24-Sep-20	25,131.96	IRWD Check	Reconciled
412053	ULINE INC	24-Sep-20	2,308.96	IRWD Check	Reconciled
412054	UNDERGROUND SERVICE ALERT OF SOUTHERN CALIFORNIA	24-Sep-20	1,430.65	IRWD Check	Negotiable
412055	UNITED PARCEL SERVICE INC	24-Sep-20	94.58	IRWD Check	Reconciled
412056	URBAN WATER INSTITUTE INC	24-Sep-20	500.00	IRWD Check	Negotiable
412057	USA BLUEBOOK	24-Sep-20	535.23	IRWD Check	Negotiable
412058	UTILITY SYSTEMS SCIENCE & SOFTWARE INC.	24-Sep-20	1,791.56	IRWD Check	Reconciled
412059	V&A CONSULTING ENGINEERS	24-Sep-20	4,083.50	IRWD Check	Reconciled
412060	VULCAN MATERIALS COMPANY	24-Sep-20	1,488.42	IRWD Check	Reconciled
412061	WALTERS WHOLESALE ELECTRIC	24-Sep-20	1,072.03	IRWD Check	Reconciled
412062	WANG, RON	24-Sep-20	13.47	IRWD Check	Negotiable
412063	WASTE MANAGEMENT COLLECTIONS AND RECYCLING, INC.	24-Sep-20	415.31	IRWD Check	Reconciled
412064	WATERLINE TECHNOLOGIES INC	24-Sep-20	3,400.00	IRWD Check	Reconciled
412065	WAXIE'S ENTERPRISES, INC	24-Sep-20	1,774.24	IRWD Check	Reconciled
412066	WCT PRODUCTS, INC.	24-Sep-20	60.00	IRWD Check	Reconciled
412067	WECK LABORATORIES INC	24-Sep-20	9,443.00	IRWD Check	Reconciled
412068	WEI, QIAN	24-Sep-20	59.88	IRWD Check	Negotiable
412069	WEST YOST & ASSOCIATES	24-Sep-20	1,080.00	IRWD Check	Reconciled
412070	WILLIAMS, JOHN	24-Sep-20	38.36	IRWD Check	Negotiable
412071	WORKFORCE SAFETY LLC	24-Sep-20	1,500.00	IRWD Check	Negotiable
412072	YSI, INC	24-Sep-20	2,897.70	IRWD Check	Reconciled
412073	YUN, SANGHEE	24-Sep-20	224.33	IRWD Check	Negotiable
412074	US BANK NAT'L ASSOCIATION NORTH DAKOTA	30-Sep-20	36,249.02	IRWD Check	Negotiable
<b>SUB-TOTAL CHECK DISBURSEMENTS</b>			<b>8,767,297.86</b>		

13957	YORK INSURANCE SERVICES GROUP INC - CA	1-Sep-20	7,342.99	IRWD Wire	Negotiable
13958	CHARD SNYDER & ASSOCIATES, INC.	1-Sep-20	1,509.60	IRWD Wire	Negotiable
13959	CHARD SNYDER & ASSOCIATES, INC.	8-Sep-20	26,516.51	IRWD Wire	Negotiable
13960	CHARD SNYDER & ASSOCIATES, INC.	8-Sep-20	3,246.11	IRWD Wire	Negotiable
13961	U.S. BANK NATIONAL ASSOCIATION	9-Sep-20	1,848.32	IRWD Wire	Negotiable
13962	BANK OF AMERICA	9-Sep-20	1,382.54	IRWD Wire	Negotiable
13963	BANK OF NEW YORK MELLON TRUST COMPANY NA	9-Sep-20	3,028.00	IRWD Wire	Negotiable
13964	CALPERS	9-Sep-20	532,288.45	IRWD Wire	Negotiable
13965	CALPERS	9-Sep-20	2,952.19	IRWD Wire	Negotiable
13966	U.S. BANK NATIONAL ASSOCIATION	10-Sep-20	1,082.93	IRWD Wire	Negotiable
13967	SUMITOMO MITSUI BANKING CORPORATION	10-Sep-20	3,651.64	IRWD Wire	Negotiable
13968	INTERNAL REVENUE SERVICE	10-Sep-20	222,683.93	IRWD Wire	Negotiable
13969	FRANCHISE TAX BOARD	10-Sep-20	67,148.43	IRWD Wire	Negotiable
13970	EMPLOYMENT DEVELOPMENT DEPARTMENT	10-Sep-20	14,623.00	IRWD Wire	Negotiable
13971	CALIFORNIA DEPARTMENT OF CHILD SUPPORT SERVICES	10-Sep-20	2,156.63	IRWD Wire	Negotiable
13972	GREAT-WEST LIFE & ANNUITY INSURANCE COMPANY	10-Sep-20	165,015.41	IRWD Wire	Negotiable
13973	LENNAR HOMES OF CALIFORNIA, INC.	10-Sep-20	204,653.77	IRWD Wire	Negotiable
13974	CALPERS	10-Sep-20	1,574.52	IRWD Wire	Negotiable

**IRVINE RANCH WATER DISTRICT  
AP DISBURSEMENTS AND VOIDS FOR SEPTEMBER 2020**

<b>CHECK OR ELECTRONIC #</b>	<b>SUPPLIERS</b>	<b>PAYMENT DATE</b>	<b>PAYMENT AMOUNT</b>	<b>PAYMENT METHOD</b>	<b>STATUS</b>
13975	CALPERS	10-Sep-20	252,506.87	IRWD Wire	Negotiable
13976	WELLS FARGO BANK, N.A.	14-Sep-20	7,401.26	IRWD Wire	Negotiable
13977	CHARD SNYDER & ASSOCIATES, INC.	14-Sep-20	2,395.48	IRWD Wire	Negotiable
13978	CHARD SNYDER & ASSOCIATES, INC.	14-Sep-20	1,984.40	IRWD Wire	Negotiable
13979	YORK INSURANCE SERVICES GROUP INC - CA	15-Sep-20	14,377.49	IRWD Wire	Negotiable
13980	JACKSON TIDUS, A LAW CORPORATION	16-Sep-20	4,788.00	IRWD Wire	Negotiable
13981	FILANC-BALFOUR BEATTY JV	17-Sep-20	115,874.25	IRWD Wire	Negotiable
13982	FILANC-BALFOUR BEATTY JV	17-Sep-20	844.22	IRWD Wire	Negotiable
13983	CHARD SNYDER & ASSOCIATES, INC.	21-Sep-20	969.44	IRWD Wire	Negotiable
13984	CHARD SNYDER & ASSOCIATES, INC.	21-Sep-20	2,456.76	IRWD Wire	Negotiable
13985	MUNICIPAL WATER DISTRICT OF ORANGE COUNTY	21-Sep-20	1,497,217.59	IRWD Wire	Negotiable
13986	MERRILL LYNCH CAPITAL SERVICES, INC	21-Sep-20	791,025.13	IRWD Wire	Negotiable
13987	CITIGROUP GLOBAL MARKETS INC.	21-Sep-20	791,025.13	IRWD Wire	Negotiable
13988	YORK INSURANCE SERVICES GROUP INC - CA	23-Sep-20	3,425.20	IRWD Wire	Negotiable
13989	ANAND, GUNJAN	23-Sep-20	22.76	IRWD Wire	Negotiable
13990	INTERNAL REVENUE SERVICE	23-Sep-20	225,526.43	IRWD Wire	Negotiable
13991	FRANCHISE TAX BOARD	23-Sep-20	68,507.25	IRWD Wire	Negotiable
13992	EMPLOYMENT DEVELOPMENT DEPARTMENT	23-Sep-20	14,274.73	IRWD Wire	Negotiable
13993	CALIFORNIA DEPARTMENT OF CHILD SUPPORT SERVICES	23-Sep-20	2,156.63	IRWD Wire	Negotiable
13994	GREAT-WEST LIFE & ANNUITY INSURANCE COMPANY	23-Sep-20	169,835.50	IRWD Wire	Negotiable
13995	CALPERS	24-Sep-20	252,100.39	IRWD Wire	Negotiable
13996	CHARD SNYDER & ASSOCIATES, INC.	28-Sep-20	1,260.44	IRWD Wire	Negotiable
13997	CHARD SNYDER & ASSOCIATES, INC.	28-Sep-20	3,443.55	IRWD Wire	Negotiable
13998	YORK INSURANCE SERVICES GROUP INC - CA	29-Sep-20	4,568.85	IRWD Wire	Negotiable
13999	BANK OF NEW YORK MELLON TRUST COMPANY NA	29-Sep-20	520.83	IRWD Wire	Negotiable
14000	ORANGE COUNTY WATER DISTRICT	29-Sep-20	2,613,852.46	IRWD Wire	Negotiable
14001	BANK OF AMERICA MERRILL LYNCH	29-Sep-20	92,666.73	IRWD Wire	Negotiable
<b>SUB-TOTAL ELECTRONIC DISBURSEMENTS</b>			<b>8,197,732.74</b>		
<b>SUB-TOTAL AP CHECK AND ELECTRONIC DISBURSEMENTS</b>			<b>16,965,030.60</b>		
<b>SUB-TOTAL CHECK AND ELECTRONIC ISSUED AND VOIDED IN SEP 2020</b>			-		
<b>TOTAL AP DISBURSEMENTS AND VOIDS FOR SEP 2020</b>			<b>16,965,030.60</b>		



Note: This page is intentionally left blank.

Exhibit "E"

**MONTHLY SUMMARY OF PAYROLL ACH PAYMENTS**

**September  
2020**

	AMOUNT	VENDOR	PURPOSE
9/11/2020	1,054,122.98	BANK OF AMERICA	ACH Payments for Payroll
9/25/2020	1,071,465.77	BANK OF AMERICA	ACH Payments for Payroll
	<u><b>\$2,125,588.75</b></u>		

Note: This page is intentionally left blank.

## Exhibit "F"

### IRWD Gov Code 53065.5 Disclosure Report

Payment or Reimbursements for Individual charges of \$100 or more per transaction for services or product received.

01-SEP-20 to 30-SEP-20

NAME	CHECK NUMBER	CHECK DATE	AMOUNT	ITEM DESCRIPTION	EXPENSE JUSTIFICATION
Cascelli, Craig	411401	3-Sep-20	192.00	Membership Renewal	CWEA Collections Grade II
Corey, Jo Ann	411594	10-Sep-20	223.01	Other(Misc)	Color Printer Ink - Working remotely at home
Coria, Alex	411595	10-Sep-20	150.00	Certification Renewal	SWRCB Wastewater Operator Grade III
Coria, Alex	411595	10-Sep-20	192.00	Membership Renewal	CWEA Collections Grade II
Danielson, Gregg	411745	17-Sep-20	118.47	Other(Misc)	Safety Shoe Allowance
Garcia, Alex	411907	24-Sep-20	400.00	Certification Renewal	AVO Substation Maintenance Technician
Garcia, Alex	411907	24-Sep-20	192.00	Membership Renewal	CWEA Electrical/Instrumentation
Mares, Michael	411746	17-Sep-20	100.00	Certification Renewal	Cross Connection Specialist
Mares, Michael	411746	17-Sep-20	130.00	Membership Renewal	SWRCB Water Treatment Grade IV
Mares, Michael	411746	17-Sep-20	105.00	Certification Renewal	SWRCB Water Treatment Grade IV
Rattan, Somkit	411747	17-Sep-20	107.72	Other(Misc)	Safety Shoe Allowance
Schreiner, Terrance	411910	24-Sep-20	298.00	Certification Renewal	CWEA Electrical/Instrumentation Grade IV
Weneta, John Matthew (Matt)	411407	3-Sep-20	200.00	Other(Misc)	Safety Shoe Allowance
Zamora, Victor	411408	3-Sep-20	172.39	Other(Misc)	Safety Shoe Allowance
<b>Total Amount:</b>			<b>\$2,580.59</b>		

Note: This page is intentionally left blank.

October 26, 2020  
Prepared by: J. Colston  
Submitted by: K. Burton  
Approved by: Paul A. Cook



## ACTION CALENDAR

### INTRODUCTION OF PRETREATMENT ORDINANCE FOR FACILITIES TRIBUTARY TO SOUTH ORANGE COUNTY WASTEWATER AUTHORITY

#### SUMMARY:

The current IRWD regulations to control industrial discharges to IRWD sewerage facilities tributary to the South Orange County Wastewater Authority (SOCWA) were last amended in 2015. Periodic amendments to these regulations are needed to incorporate the requirements of new state and federal pretreatment regulations to address changes in administrative procedures and/or as a result of regulatory audits. Staff recommends that the Board approve the introduction of the Ordinance, waive the reading of the Ordinance, and direct General Counsel to prepare a summary for publication, order publication, and place the Ordinance on the agenda for the November 23, 2020 Board meeting for a second reading and adoption.

#### BACKGROUND:

IRWD is required by state and federal laws and regulations to control the discharge of non-domestic sewage to its collection and treatment systems to prevent pollutants from upsetting the treatment systems or passing through to the environment. To comply with these requirements, IRWD has an established Pretreatment and Source Control Program (Pretreatment Program). Ordinance No. 2015-1 governs the Pretreatment Program for the portions of its sewage collection systems that are tributary to IRWD's Los Alisos Water Recycling Plant (LAWRP). When recycled water demand is low, all or a portion of LAWRP's secondary treated effluent is discharged to the ocean via SOCWA's Aliso Creek Ocean Outfall. SOCWA, as the owner and operator of the ocean outfall, maintains a Pretreatment Program ordinance and requires systems tributary to the ocean outfall to adopt an identical ordinance. An interagency agreement between IRWD and SOCWA defines each agency's duties and responsibilities in implementing these ordinances.

The Pretreatment Ordinance primarily regulates industrial users and regulates sewer use and discharges in compliance with applicable state and federal regulations, establishes quality and quantity limitations on all sewer discharges and imposes pretreatment requirements on the degree of waste authorized to be discharged to IRWD sewage treatment facilities that are tributary to SOCWA. The Pretreatment Ordinance also provides for the issuance of permits to impose additional case-by-case requirements as appropriate, establishes fees and other penalties for noncompliance and/or violations and establishes specific facility requirements, inspection, monitoring, sampling, notification and reporting requirements.

Revisions are made periodically to the Pretreatment Ordinance to maintain compliance with changing federal pretreatment regulations, to update administrative provisions, and/or as a result of a regulatory audit. As a result of SOCWA's recent pretreatment program audit conducted by the San Diego Regional Water Quality Control Board in December 2018, SOCWA was required

to amend its own pretreatment ordinance, and therefore IRWD must amend its companion ordinance to maintain consistency. IRWD staff worked cooperatively with SOCWA staff to incorporate the required changes to IRWD's Pretreatment Ordinance. Provided as Exhibit "A" is the proposed Pretreatment Ordinance consisting of the updated provisions for the portions of IRWD's sewage collection and treatment systems that are tributary to SOCWA. The proposed revisions to the Pretreatment Ordinance are summarized in Exhibit "B".

The Pretreatment Ordinance will repeal Ordinance No. 2015-1 and amend regulations for discharges to sewerage facilities of IRWD that are tributary to SOCWA. Adoption of an ordinance is a two-step process that requires: 1) a first reading and introduction, and 2) a second reading and adoption, tentatively scheduled for November 23, 2020.

FISCAL IMPACTS:

The Program is already being administered, and the proposed revisions are not expected to result in a significant fiscal impact to IRWD.

ENVIRONMENTAL COMPLIANCE:

The adoption of the Pretreatment Ordinance is categorically exempt from the California Environmental Quality Act pursuant to the California Code of Regulations, Title 14, Division 6, Chapter 3, Sections 15307 and 15308, which provide exemptions for actions by regulatory agencies for protection of natural resources and the environment.

COMMITTEE STATUS:

This item was reviewed by the Engineering and Operations Committee on October 20, 2020.

RECOMMENDATION:

THAT THE BOARD APPROVE THE INTRODUCTION OF AN ORDINANCE AMENDING PRETREATMENT REGULATIONS FOR DISCHARGES TO SEWERAGE FACILITIES TRIBUTARY TO THE SOUTH ORANGE COUNTY WASTEWATER AUTHORITY AND REPEALING ORDINANCE NO. 2015-1, WAIVE THE READING OF THE ORDINANCE IN ITS ENTIRETY, SET A SECOND READING ON THE ORDINANCE FOR THE BOARD'S REGULAR MEETING ON NOVEMBER 23, 2020, DIRECT THE GENERAL COUNSEL TO PREPARE A SUMMARY OF THE ORDINANCE FOR PUBLICATION, AND ORDER PUBLICATION OF THE REQUIRED PUBLIC NOTICES.

LIST OF EXHIBITS:

Exhibit "A" – Proposed Pretreatment Ordinance  
Exhibit "B" – Summary of Revisions to Ordinance

EXHIBIT "A"

IRVINE RANCH WATER DISTRICT  
WASTE DISCHARGE PRETREATMENT  
AND  
SOURCE CONTROL PROGRAM

An Ordinance Repealing Ordinance No. 201~~51~~<sup>54</sup>-1 and  
Adopting ~~Amended~~ Regulations for  
the Discharge of Wastewater to Sewerage Facilities of  
the Irvine Ranch Water District ~~that are in the~~ Tributary to  
the South Orange County Wastewater Authority ~~Service Area~~

(Pretreatment Ordinance)

ORDINANCE ~~2015~~<sup>2020</sup>-1

~~As amended xxx~~ Adopted \_\_\_\_\_, 2020

Irvine Ranch Water District  
15600 Sand Canyon Avenue Irvine, California 92618

irwd.com



**Table of Contents**

<u>Section</u>	<u>Page</u>
<b>ARTICLE 1</b>	
<b>GENERAL PROVISIONS</b>	
1.01 Introduction . . . . .	5
1.02 Objectives . . . . .	5
1.03 Purpose . . . . .	6
1.04 Policy . . . . .	7
1.05 Applicability . . . . .	7
1.06 Availability of Sewerage Facilities . . . . .	7
1.07 Notice to Employees. . . . .	8
<b>ARTICLE 2</b>	
<b>DEFINITIONS AND ABBREVIATIONS</b>	
2.01 Definitions Contained in Publications . . . . .	8
2.02 Definition of Terms . . . . .	8
2.03 Abbreviations . . . . .	20
<b>ARTICLE 3</b>	
<b>AUTHORITIES AND POWERS</b>	
3.01 Authority . . . . .	22
3.02 Delegation of Authority . . . . .	23
<b>ARTICLE 4</b>	
<b>ADMINISTRATION</b>	
4.01 By Irvine Ranch Water District . . . . .	23
4.02 By SOCWA . . . . .	24
4.03 Program Enforcement . . . . .	25
4.04 Applications . . . . .	25
4.05 Wastewater Discharge (WD) Permits. . . . .	25
4.06 Inspections, Monitoring, and Enforcement . . . . .	25
4.07 Funding . . . . .	25
4.08 Appeals . . . . .	26
<b>ARTICLE 5</b>	
<b>GENERAL DISCHARGE PROHIBITIONS AND LIMITATIONS</b>	
5.01 Prohibited Discharges . . . . .	26
5.02 Prohibition on Dilution . . . . .	27
5.03 Prohibition on Biohazardous Wastes . . . . .	27
5.04 Prohibition on Toxic or Hazardous Wastes . . . . .	27
5.05 Prohibition on Warfare Agents . . . . .	27
5.06 Limitations on Disposal of Spent Solutions and Sludges . . . . .	27
5.07 Limitations on the Use of Grinders. . . . .	28
5.08 Limitations on Rainwater, Stormwater, and Street Drainage. . . . .	28
5.09 Limitations on Groundwater and Subsurface Drainage . . . . .	28
5.10 Limitations on Trucked or Hauled Wastes . . . . .	28
5.11 Limitations on Point of Discharge . . . . .	29
5.12 Limitations on Radioactive Wastes . . . . .	29
5.13 Limitations on Unpolluted Water . . . . .	29

Section	Page	
5.14	Mass Emission Limit Determination . . . . .	29
5.15	Wastewater Strengths and Characteristics. . . . .	30
5.16	Specific Local Limits . . . . .	31
5.17	State Requirements . . . . .	31
5.18	Federal Requirements . . . . .	32

**ARTICLE 6  
WASTEWATER DISCHARGE PERMITS**

6.01	Written Authorization . . . . .	32
6.02	Types of Wastewater Discharge Permits . . . . .	32
6.03	Transfer Prohibition . . . . .	33
6.04	Change of Ownership. . . . .	33
6.05	Excess Capacity Regulatory Fee . . . . .	33
6.06	Out of Service Area Wastewater Discharge Permits . . . . .	33
6.07	Required Information . . . . .	33
6.08	Confidential Information . . . . .	34
6.09	Class I - Wastewater Discharge (WD) Permit. . . . .	34
6.10	Class II - Wastewater Discharge (WD) Permit . . . . .	34
6.11	Class III - Wastewater Discharge (WD) Permit . . . . .	34
6.12	Class IV - Special Wastewater Discharge (SWD) Permit . . . . .	35
6.13	Non-Industrial Wastewater Discharge (NIWD) Form . . . . .	35
6.14	Application for Wastewater Discharge Permit. . . . .	35
6.15	Application for Special Wastewater Discharge Permit. . . . .	36
6.16	Application for Non-Industrial Wastewater Discharge (NIWD) Form . . . . .	37
6.17	Wastewater Discharge Permit Terms, Conditions, and Limitations. . . . .	38
6.18	Wastewater Discharge Permit Duration . . . . .	39
6.19	Wastewater Discharge Permit Renewal . . . . .	39
6.20	IRWD's Right of Revision . . . . .	40

**ARTICLE 7  
PRETREATMENT EQUIPMENT REQUIREMENTS**

7.01	Pretreatment. . . . .	40
7.02	Spill Containment . . . . .	40
7.03	Monitoring and Metering Equipment. . . . .	41
7.04	Drawing Submittals . . . . .	41
7.05	Waste Minimization, Recycling, and Treatment . . . . .	42

**ARTICLE 8  
INSPECTION, MONITORING, SAMPLING,  
NOTIFICATION, AND REPORTING REQUIREMENTS**

8.01	Inspection and Monitoring . . . . .	42
8.02	Self-Monitoring and Reporting . . . . .	43
8.03	Report of Spill, Slug Discharge, Batch Dumping, or Upset . . . . .	46
8.04	Reporting of By-pass. . . . .	46
8.05	Baseline Monitoring Reports (40 CFR 403.12(b)). . . . .	47
8.06	Report on Progress in Meeting Compliance Schedules (40CFR 403.12(c)). . . . .	48
8.07	Report on Compliance with Categorical Pretreatment Standards Deadline (40 CFR 403.12(d)) . . . . .	49
8.08	Periodic Compliance Report . . . . .	49
8.09	Right of Entry. . . . .	50
8.10	Analytical Requirements . . . . .	50
8.11	Sample Collection . . . . .	50

Section	Page
8.12 Timing . . . . .	51
8.13 Notification of Changed Discharge . . . . .	51
8.14 Notification of the Discharge of Hazardous Waste (40 CFR 403.12 (P)(1)) . . . . .	51

**ARTICLE 9**  
**ENFORCEMENT**

9.01 Enforcement Scope . . . . .	52
9.02 Notice of Noncompliance (NON) . . . . .	53
9.03 Notice of Violation (NOV) . . . . .	53
9.04 Administrative Orders (AO) . . . . .	53
9.05 Wastewater Discharge Permit Suspension or Revocation . . . . .	54
9.06 Termination of Service . . . . .	56
9.07 Emergency Suspension . . . . .	56
9.08 Injunction . . . . .	56
9.09 Civil Fines and Penalties . . . . .	56
9.10 Criminal Penalties . . . . .	59
9.11 Public Nuisance . . . . .	59
9.12 Appeals to the General Manager . . . . .	60
9.13 Appeals to the Board . . . . .	61
9.14 Judicial Review . . . . .	62
9.15 Payment and Collection of Fees and Charges . . . . .	63
9.16 Recovery of Enforcement Costs . . . . .	63
9.17 Financial Security Conditions . . . . .	63
9.18 Report of Analysis . . . . .	64
9.19 Damage to Facilities or Interruption of Normal Operation . . . . .	65
9.20 Industrial Waste Pass Through . . . . .	65
9.21 Batch Dumps . . . . .	65
9.22 Publication of Users in Significant Noncompliance (SNC) . . . . .	65

**ARTICLE 10**  
**FEES AND CHARGES**

10.01 Application Fee . . . . .	66
10.02 Annual Wastewater Discharge Permit Fees . . . . .	66
10.03 Inspection, Monitoring and Sampling Charges . . . . .	66
10.04 Delinquency Fees . . . . .	66
10.05 Additional Fees and Charges . . . . .	66
10.06 Recording of Fees and Charges . . . . .	66

**ARTICLE 11**  
**SEVERABILITY**

11.01 Severability . . . . .	67
------------------------------	----

**ARTICLE 12**  
**REPEAL**

12.01 Repeal . . . . .	67
------------------------	----

**ARTICLE 13**  
**EFFECTIVE DATE**

13.01 Effective Date . . . . .	67
--------------------------------	----

| ~~[to be inserted following finalization of sections]~~

**THE BOARD OF DIRECTORS OF THE IRVINE RANCH WATER DISTRICT HEREBY DOES  
ORDAINS AS FOLLOWS:**

**ARTICLE 1  
GENERAL PROVISIONS**

**1.01 INTRODUCTION**

- A. The Irvine Ranch Water District ("IRWD") was organized in 1961 ~~by authority of under~~ the California Water District Law (Section 34000 of the Water Code of the State of California). ~~The IRWD is governed by a five member Board of Directors (Board) elected from the qualified voters in the entire IRWD service area. For the purpose of this ordinance, the IRWD~~IRWD provides ~~water distribution and~~ wastewater collection and treatment services to residential and commercial establishments in the City of Lake Forest area, ~~which~~ ~~Ww~~wastewater is treated at ~~the IRWD~~IRWD's Los Alisos Wastewater Reclamation Plant. ~~Any unused wastewater is discharged to the ocean via the South Orange County Wastewater Authority's (SOCWA) Aliso Creek Ocean Outfall.~~
- B. ~~The South Orange County Wastewater Authority (SOCWA) is a joint powers authority that is governed by its own Board of Directors with each director representing a member agency (MA). MAs join together in various project committees to construct and owns and operates joint sewerage facilities in south Orange County, including effluent transmission main pipelines and ocean outfalls. SOCWA is the holder of the NPDES permits, which states regulating the pretreatment and waste discharge requirements for the sewerage facilities. Any unused IRWD discharges wastewater from the Los Alisos Wastewater Reclamation Plant is discharged to the ocean via the South Orange County Wastewater Authority's (SOCWA) to SOCWA's Aliso Creek Effluent Transmission Main pipeline, and ultimately to SOCWA's Aliso Creek Ocean Outfall. The SOCWA Ocean Outfalls are the key facilities in the SOCWA system. Treated wastewater is discharged to the outfalls from SOCWA and the IRWD~~IRWD's wastewater treatment plants.
- C. ~~SOCWA, IRWD, and Santa Margarita Water District are parties to a *Multijurisdictional Agreement Regarding Pretreatment Program Implementation and Enforcement* effective May 20, 2003 (Multijurisdictional Agreement), that provides for joint administration and enforcement of an industrial pretreatment program designed to ensure compliance with NPDES and other regulatory requirements in connection with IRWD's use of SOCWA's facilities. This ordinance is intended to fulfill IRWD's duties under the Multijurisdictional Agreement to adopt a pretreatment ordinance and enforcement response plan consistent with SOCWA's pretreatment program. SOCWA is the lead agency responsible for the implementation of the provisions contained in this ordinance. The IRWD, a MA of SOCWA may opt to administer and enforce these provisions under SOCWA's oversight, or may contract with SOCWA to have these services provided directly to the IRWD. An interagency agreement has been adopted between the IRWD and SOCWA that defines each agency's duties and responsibilities. This interagency agreement is on file at the IRWD and SOCWA offices.~~
- C-D. This ordinance may be referred to as the "Pretreatment Ordinance."

## 1.02 OBJECTIVES

- A. The objectives of this ordinance are to:
1. Ensure compliance with various regulatory agencies and the National Pollutant Discharge Elimination System (NPDES) ~~Requirements~~requirements.
  2. Prevent the introduction of pollutants that may cause interference of sewerage facility operations.
  3. Identify the goals, objectives and procedures for complying with federal pretreatment standards.
  4. Prevent biosolids contamination.
  5. Promote the opportunity to recycle and reclaim wastewaters or biosolids from sewerage facilities.
  6. Encourage waste minimization and material substitution by users.
  7. Protect sewerage facility employees and the general public who may be affected by wastewater, biosolids and chemical hazards.
  8. Encourage the reuse, recycling and reduction of water, wastewater or solids that are discharged to sewerage facilities.
  9. Minimize the discharge of volatile organic compounds that could individually or collectively contribute to a decrease in the quality of air emission from sewerage facilities.
  10. Establish an effective monitoring program for the control of user discharges to sewerage facilities.
  11. Establish an enforcement response plan (ERP) consistent with SOCWA's pretreatment program. ~~to help ensure consistent application of the provisions of this Ordinance.~~
  12. Equitably distribute costs among users.
  13. Prevent the introduction of pollutants into sewerage facilities that may pass through a sewerage facility, inadequately treated, into the receiving waters, or otherwise be incompatible with sewerage facilities.
  14. Incorporate the necessary laws and regulations in order to implement and enforce federal, State of California (State), IRWD and SOCWA standards.
  15. Seek to identify users that discharge or have the potential to discharge toxic pollutants, non-compatible or excessive amounts of compatible wastes to sewerage facilities.

### 1.03 PURPOSE

- A. The purpose of this ordinance is to:
1. Provide for the maximum public benefit from the use of IRWD sewerage facilities. This is accomplished by regulating the use of sewerage facilities and wastewater discharges by providing equitable distribution of costs in compliance with applicable state and federal regulations and by providing procedures that will allow ~~the IRWD~~IRWD to comply with requirements placed upon it by other regulatory agencies. Any revenues derived from the application of this ordinance may be used to recover the cost of providing services by ~~the IRWD~~IRWD which includes but are not limited to administration, monitoring, and enforcement.
  2. Comply with federal and state regulations which allow ~~the IRWD~~IRWD to meet applicable standards for the final effluent and ocean outfall quality. This ordinance establishes quality and quantity limitations on all wastewater discharges whether or not the discharges adversely affect IRWD's sewerage facilities, processes, ocean outfall effluent quality, or inhibit IRWD's ability to meet its specific discharge limitations. It is the intent of this ordinance to improve the quality of wastewater being received for treatment and to encourage water conservation by all users connected to a sewerage facility. It is ~~the IRWD~~IRWD's intent to discourage the increase in quantity (mass emission) of waste constituents being discharged. This ordinance also imposes pretreatment requirements on the degree of waste authorized to be discharged to ~~the IRWD~~IRWD's sewerage facilities; provides for the issuance of wastewater discharge permits or other controlling mechanism to impose additional case-by-case requirements, as appropriate, and establishes fees and other penalties for noncompliance and/or violation of this ordinance.

### 1.04 POLICY

- A. The policy of this ordinance is to be:
1. Interpreted in accordance with the definitions set forth in Article 2. The provisions of this ordinance shall apply to the discharge of all wastes carried to IRWD sewerage facilities tributary to SOCWA facilities, and ~~have been~~should be liberally construed so as to effectuate the environmental purposes, objectives, and other provisions set forth herein.
  2. Committed to wastewater reclamation and reuse in order to provide an alternate source of water supply. The adoption of programs for reclamation through secondary and tertiary wastewater treatment processes may necessitate more stringent quality requirements on wastewater discharges. In the event that more stringent quality requirements are necessary, this ordinance may be amended to reflect those changes.
  3. Committed to the beneficial use of biosolids. The implementation of programs to land apply or provide for the marketing and distribution of biosolids may necessitate more stringent quality requirements on waste-water discharges. In the event that more stringent quality requirements are necessary, this ordinance may be amended to reflect these changes.

4. Committed to compliance with all applicable state and federal laws including the Clean Water Act in 33 United States Code 1251 et seq. and the general pretreatment regulations described in 40 CFR 403.

#### 1.05 APPLICABILITY

This ordinance ~~may apply~~applies to ~~all users within the IRWD service area and to users outside the IRWD service area who, by wastewater discharge permit or other controlling mechanism, make users persons that~~ use ~~of any~~ IRWD sewerage facilities that are ~~within the tributary to SOCWA service area~~facilities.

#### 1.06 AVAILABILITY OF SEWERAGE FACILITIES

If capacity in a sewerage facility as a whole is not available, IRWD may restrict discharge of existing users until sufficient capacity can be made available. ~~The IRWD~~IRWD may refuse immediate service to new users where their proposed quality or quantity of wastewater is unacceptable to the available sewerage facilities.

#### 1.07 NOTICE TO EMPLOYEES

A. ~~The IRWD~~ may shall provide ~~one (1) copy of~~ this ordinance to each user that has received a wastewater discharge permit, upon request.

~~B.~~ Users who are issued a wastewater discharge permit may shall make copies of this ordinance available to their employees, ~~copies of this ordinance~~.

~~C.B.~~ ~~Users who are issued a wastewater discharge permit may make copies of it, so as to make it available to all personnel~~ at all times.

~~D.C.~~ All industrial dischargers shall permanently post a notice ~~may be permanently posted~~ in prominent places advising employees to call ~~the IRWD~~IRWD in the event of an uncontrolled spill or discharge as soon as possible and to submit a report as indicated in section 8.03 or 8.04 of this ordinance. The notice shall provide for necessary instruction and information, including but not limited to:

1. IRWD phone numbers.
2. SOCWA phone numbers.
3. Recording the time of the incident.
4. Name and location of user.
5. Type, concentration and volume of the discharge.
6. Corrective action taken.
7. Name of person reporting the incident.



## ARTICLE 2 DEFINITIONS AND ABBREVIATIONS

### 2.01 DEFINITIONS CONTAINED IN PUBLICATION

- A. Unless otherwise defined herein, terms related to water quality shall be defined in the same manner as in the latest edition of Standard Methods for the Examination of Water and Wastewater, published jointly by the American Public Health Association (APHA), The American Water Works Association (AWWA), and the Water Environment Federation (WEF).
- B. The testing procedure for waste constituents and characteristics shall be as described in 40 CFR 136.

### 2.02 DEFINITION OF TERMS

- A. Words used in this ordinance in the singular may include the plural and the plural singular. Use of masculine shall mean feminine and the use of feminine shall mean masculine.
- B. The definitions in this ordinance are not intended to narrow the scope of definitions set forth in federal or state regulations. Unless the context specifically indicates otherwise the following terms, or pronouns used in their place, shall be interpreted as follows:
  - 1. Act or "the Act". The Federal Water Pollution Control Act also known as the Clean Water Act (~~CWA~~) as well as any amendments, guidelines, limitation or standards promulgated by the EPA pursuant to the Act, (33 USC 1251 et seq.).
  - 2. Approval Authority. Refers to the US Environmental Protection Agency (EPA), the California State Water Resources Control Board (SWRCB), or the local California Regional Water Quality Control Board (RWQCB).
  - 3. Baseline Monitoring Report (BMR). A required report for all industrial users subject to a categorical pretreatment standard. A BMR provides information that documents an industrial user's compliance status with all applicable pretreatment standards.
  - 4. Batch Dump. The discharge of pollutants or compatible wastes in a manner or method that is not approved or is prohibited by ~~the IRWD~~IRWD.
  - 5. Best Available Technology (BAT). A level of technology that is based on the very best (state of the art) control and treatment measures that have been developed or are capable of being developed for a particular industrial category.
  - 6. Best Management Practices (BMPs). A set of schedules of activities, prohibitions of practices, maintenance procedures, operating procedures and other management practices used to control a user or a group of similar users' discharge to sewerage facilities. BMPs may include, but are not limited to treatment requirements, operating procedures, and practices to control plant site runoff, spillage of leaks, sludge or waste disposal, or drainage from raw materials storage.

7. Best Practicable Technology (BPT). A level of technology represented by the average of the best existing wastewater treatment performance levels within an industrial category.
8. Biochemical Oxygen Demand (BOD). The quantity of oxygen utilized in the biochemical oxidation of organic matter in wastewater using appropriate testing procedure and expressed as a concentration (e.g. mg/L).
9. Biodegradable. A material that can be decomposed by a biological process.
10. Biohazardous Waste. ~~area-Any~~ material that is likely to transmit etiologic agents that cause, or significantly contribute to the cause of, increased morbidity or mortality of human beings as set forth by the State Medical Waste Management Act.
11. Board. The Board of Directors of the Irvine Ranch Water District ~~(IRWD)~~.
12. Building Sewer. The entire length of private sewage service lateral extending from the building or structure ~~that is connected to the~~ to a sewerage facility, and including the connection to that sewerage facility.
13. By-Pass. Any intentional diversion of waste streams around any portion of a user's pretreatment equipment.
14. Categorical Industrial User (CIU). A user subject to a federal categorical pretreatment standard or categorical standard
15. Chain of Custody. A document used to ensure the integrity of a sample, which includes a record of each person involved in the possession of a sample, securing the sample, and final disposal of the sample.
16. Chemical Oxygen Demand (COD). The quantity of oxygen required to oxidize all compounds, both organic and inorganic, in wastewater using the appropriate testing procedure and expressed as a concentration (e.g. mg/L).
17. Class I User. Any user determined by ~~the IRWD~~IRWD that meets the criteria of significant industrial user (SIU) as described in 40 CFR 403.
18. Class II User. Any user determined by ~~the IRWD~~IRWD that is not a SIU and may discharge pollutants or non-compatible wastes which may impact sewerage facilities.
19. Class III User. Any user determined by ~~the IRWD~~IRWD that is not a SIU and may discharge conventional pollutants or compatible wastes, which may impact sewerage facilities.
20. Class IV User. Any user determined by IRWD that may discharge or is proposing to discharge special wastewater that may contain toxic or conventional pollutants, or non-compatible or compatible wastes which may impact sewerage facilities.

21. Code of Federal Regulations (CFR). The code of the Federal Government of the United States of America, which contains all of the federal regulations including environmental regulations.
22. Company Authorized Representative (CAR). An individual designated by the user, who is responsible for signing all submittals to ~~the IRWD~~IRWD and who meets the criteria as described in 40 CFR 403.
23. Compatible Waste. Waste that does not contain toxic pollutants or non-compatible wastes. This may include a combination of, but is not limited to, conventional pollutants or other wastes that sewerage facilities are designed to accept and/or remove. Compatible wastes are non-compatible when discharged in quantities that have an adverse effect on sewerage facilities or violate SOCWA's NPDES Permit, or when discharged in qualities or quantities violating any National Pretreatment Standard or other discharge requirement or as determined by ~~the IRWD~~IRWD.
24. Composite Sample. A collection of individual samples obtained at intervals based on an increment of either flow or time. The resulting mixture, a composite sample, forms a representative sample of the wastestream discharged during the sample period.
25. Control Authority (CA). The Irvine Ranch Water District (IRWD) and/or the South Orange County Wastewater Authority (SOCWA).
26. Conventional Pollutants. Those pollutants which are designated pursuant to section 304(a)(4) of the Act which include, biochemical oxygen demand (BOD), total suspended solids (TSS), fecal coliform, pH, and oil and grease.
27. Daily Maximum. The arithmetic average of all effluent samples for a pollutant collected during a calendar day.
28. Daily Maximum Limit. The maximum allowable discharge limit of a pollutant during a calendar day. Where Daily Maximum Limits are expressed in units of mass, the daily discharge is the total mass discharged over the course of the day. Where Daily Maximum Limits are expressed in terms of a concentration, the daily discharge is the arithmetic average measurement of the pollutant concentration derived from all measurements taken that day.
29. Discharger. Any entity which discharges or causes a discharge of wastewater that is directly or indirectly discharged to sewerage facilities. May be interchangeable with indirect discharger, industrial user, permittee, person or user.
30. Discharge Requirements. The requirements of federal, state or local public agencies having jurisdiction over the effluent discharged sewerage facilities or the environment.
31. Dry Weather Nuisance Flow (nuisance flow). Any water or other discharge which finds its way to that is received into storm drains from urban areas. Nuisance flow is, composed primarily of runoff from lawn or landscape watering, washing of

vehicles, hosing down of paved areas, storm drain infiltration, natural groundwater from sub-drain systems and a variety of other sources associated with urban activity. This nuisance flow may be high in bacteriological contamination, oil and grease, and may have high organic and inorganic mineral content. Nuisance flow does not include stormwater, as defined, unless stormwater is captured, treated, controlled (thereby becoming a non-stormwater, nuisance flow) and discharged to the sewer during dry weather. Nuisance flows may come in contact with people or the environment in undesirable ways. Nuisance flow is a component of urban runoff.

32. Disposal. A controlled release to sewerage facilities or to the environment.
33. Effluent. Usually water or wastewater discharged partially or completely treated or untreated from any part of an industrial user or treatment plant, ~~or part thereof.~~
34. Enforcement. A series of progressively more stringent actions used to seek compliance with federal, state or local laws, regulations, limitations and this ordinance, and guided by the Enforcement Response Plan, adopted as Resolution 2009-02, and as may be amended from time to time, guided by the Enforcement Response Plan, adopted as Resolution 2009-02. Any enforcement may include monetary fees, fines or penalties.
35. Environmental Protection Agency (EPA). The U.-S. Environmental Protection Agency or, where appropriate, the Regional Water Management Division Director, the Regional Administrator, or other duly authorized official of said agency.
36. Existing Source. Any source of discharge that is not a "New Source".
37. Fee. Any amount assessed to a discharger for the use of any portion of a sewerage facility which shall include, but not be limited to, connection fees, monthly sewer service, wastewater discharge permit, excess capacity fee, industrial wastewater treatment, laboratory testing, industrial inspection, and monitoring fees.
38. Flow Monitoring Equipment. Equipment and/or structures provided at the user's sole expense to measure, totalize, record and/or sample incoming water to the user's site or the wastewater discharged to sewerage facilities.
39. General Manager. The individual duly designated by the Board of ~~the~~ IRWD/IRWD to administer this ordinance.
40. Grab Sample. A sample collected from a wastestream without regard to the flow in the wastestream and over a period of time not to exceed fifteen (15) minutes..
41. Grease. Includes, but is not limited to fats, oils and grease (FOG), waxes and other non-volatile materials as determined by the appropriate testing procedures.
42. Groundwater. Water that is beneath the surface of the earth.

43. Hazardous Waste. Any waste that is potentially damaging to of the environment or a person's health due to toxicity, ignitability, corrosivity, chemical reactivity or other reasons.
44. Indirect Discharge or Discharge. The introduction of Pollutants into a POTW from any non-domestic source regulated under section 307(b), (c), or (d) of the Act.
45. Industrial User. Any site that discharges industrial wastewater to sewerage facilities. May be interchangeable with discharger, indirect discharger, permittee or user.
46. Industrial Wastewater. All liquid-carried wastes or wastewater of the community, excluding domestic wastewater, and may include all wastewater from any producing, manufacturing, processing, agricultural, or other operation or location.Inspector. A person authorized by the General Manager to inspect and/or monitor any industrial user's discharge or anticipated discharge to any sewerage facility.
48. Interference. A discharge that, alone or in conjunction with a discharge or discharges from other sources, inhibits or disrupts any sewerage facilities, any treatment processes or operations or any sludge processes, use or disposal and therefore, is a cause of violation of ~~the IRWD~~IRWD's or SOCWA's NPDES permits (including an increase in the magnitude or duration of a violation) or prevents lawful biosolids or treated effluent use or disposal.
49. Interjurisdictional Agreements (Also referred to as Interagency Agreements). An agreement between SOCWA and any individual or combination of MA's or other local sewerage agency that defines the authority and responsibility to implement the Waste Discharge Pretreatment and Source Control Program and to enforce the regulations contained in this ordinance within the individual and/or combination of MAs, or any other local sewerage agency's service area.
- ~~50. Irvine Ranch Water District (IRWD). The agency that is responsible for the adoption of this ordinance and is a MA of SOCWA.~~
- ~~51.~~50. Local Limits. A set of specific discharge limits developed and enforced by ~~the IRWD~~IRWD and/or SOCWA ~~upon a user's site~~ in order to implement the general and specific discharge prohibitions as described in 40 CFR 403.
- ~~52.~~51. Local Sewering Agency. Any public agency or private company responsible for the collection, treatment or disposal of wastewater to sewerage facilities that are duly authorized under the laws of the State to construct and/or maintain sewerage facilities.
- ~~53.~~52. Lower Explosive Limit (LEL). The point where an explosive gas in an area of atmosphere that is at a sufficient concentration as to result in an explosion if a sufficient ignition source is present.
- ~~54.~~53. Mass Emission Rate. The weight of material discharged to sewerage facilities during a given time interval. Unless otherwise specified, the mass emission rate

shall mean pounds per day of a particular constituent or combinations of constituents.

~~55-54.~~ May. Permissive or discretionary.

~~56-55.~~ Member Agency (MA). Any one, combination, or all of the ~~individual districts or cities which are~~ members of SOCWA. ~~They are: City of Laguna Beach (CLB), City of San Clemente (CSC), City of San Juan Capistrano (CSJC), El Toro Water District (ETWD), Emerald Bay Service District (EBSD), Irvine Ranch Water District (IRWD), Moulton Niguel Water District (MNWD), Santa Margarita Water District, (SMWD), South Coast Water District, (SCWD) and the Trabuco Canyon Water District (TCWD).~~

~~57-56.~~ Monthly Average. The sum of all "daily discharges" measured during a calendar month divided by the number of "daily discharges" measured during the month.

~~58-57.~~ National Pollutant Discharge Elimination System (NPDES) Permit. The document issued for the control of discharges to surface waters of the United States as detailed in Section 402 of the Act.

~~59-58.~~ National Pretreatment Standards. Includes the following terms established pursuant to 40 CFR 403.5 and 40 CFR 403.6: "Prohibited Discharges", "General Prohibitions", "Specific Prohibitions", "Local Limits", "Categorical Standards", "Categorical Pretreatment Standards", "Pretreatment Standards" and "Standards". These terms apply to any pollutant discharge regulations that are promulgated by the EPA in accordance with Section 307 (b) and (c) of the Act that limits and/or prohibits the wastewater discharged by users into a sewerage facility.

~~60-59.~~ New Source. Those sources that are new as defined by 40 CFR 403.3(m).

~~61-60.~~ Non-Compatible Waste. Waste that contains toxic or non-compatible pollutants that may pass-through or cause interference if discharged to sewerage facilities.

~~62-61.~~ Non-Stormwater Discharge. Discharges that do not immediately originate from precipitation events unless precipitation is captured and discharged after a rain event. Including but not limited to: discharges of process water, air conditioner condensate, non-contact cooling water, vehicle wash water, sanitary wastes, concrete washout water, paint wash water, irrigation water, or pipe testing water.

~~63-62.~~ Non-industrial Wastewater Discharge (NIWD) Form. A form issued users that are considered to have wastewater of no concern discharging to sewerage facilities. This form may contain BMP's.

~~64-63.~~ Normal Working Day. Any period of time during which production or operation is taking place or any period which discharge to sewerage facilities is occurring..

~~65-64.~~ North America Industry Classification System (NAICS). An industry classification system that groups establishments into industries based on the activities which they are primarily engaged.



- ~~66-65.~~ Nuisance. Anything which may be injurious to health or is indecent or offensive to the senses or an obstruction to the free use of property so as to interfere with the comfort or enjoyment of life or property or which affects at the same time an entire community or neighborhood or any considerable number of persons, although the extent of the annoyance or damage inflicted upon individuals may be unequal.
- ~~67.~~ ~~Ordinance. The document entitled "An Ordinance of Regulations for the Discharge of Wastewater to Sewerage Facilities of the Irvine Ranch Water District Service Area" containing IRWD's requirements, conditions and limitations for discharging to sewerage facilities, as may be amended and modified.~~
- ~~68.~~ 66. Pass Through. A discharge from a user which exits sewerage facilities into waters of the United States in quantities or concentrations which, alone or in conjunction with any discharge from other sources, is a cause of a violation of any requirement of IRWD's or SOCWA's NPDES Permits, including an increase in the magnitude or duration of a violation. Permittee. A discharger who has received a permit to discharge wastewater into ~~the IRWD~~IRWD's sewerage facilities subject to the requirements and conditions established by ~~the IRWD~~IRWD. May be interchangeable with discharger, indirect discharger, industrial user, person or user.
- ~~70.~~ 68. Person. Any individual, partnership, copartnership, firm, company, corporation, association, joint stock company, trust, estate, tenant, lessee, renter, governmental entity, or any other legal entity; or their legal representatives, agents or assigns. This definition includes all federal, state and local government entities. May be interchangeable with discharger, indirect discharger, industrial user, permittee or user.
- ~~71.~~ 69. Pesticides. Those compounds classified as such under Federal or State law or regulations including, but not limited to, DDT (dichlorodiphenyltrichloroethane, both isomers), DDE (dichlorodiphenylethylene), DDD (dichlorodiphenyldichloroethane), Aldrin, Benzene Hexachloride (alpha, beta and gamma isomers), Chlordane, Endrin, Endrin aldehyde, TCDD (2,3,7,8-tetrachlorodibenzo-p-dioxin), Toxaphene, Alpha-endosulfan, Beta-endosulfan, Endosulfan sulfate, Heptachlor, Heptachlor epoxide, Dieldrin Demeton, Guthion, Malathion, Methoxychlor, Merex and Parathion.
- ~~72.~~ 70. pH. A measure of the acidity or alkalinity of a solution, expressed in standard units.
- ~~73.~~ 71. Pollutant. Any substance, constituent, compound or characteristic of wastewaters on which a discharge limitation may be imposed either by ~~the IRWD~~IRWD, SOCWA, or the regulatory agencies empowered to regulate ~~the IRWD~~IRWD and SOCWA.
- ~~74.~~ 72. Polychlorinated Biphenyls (PCBs). Those compounds classified as such under Federal and State law or regulations including, but not limited to Aroclors 1016, 1221, 1228, 1232, 1242, 1248, 1254, 1260 and 1262.

- ~~75.73.~~ Pretreatment. The reduction of the amount of pollutants, the elimination of pollutants, or the alteration of the nature of pollutant properties in wastewater prior to or in lieu of introducing such pollutants into sewerage facilities. This reduction, elimination or alteration of pollutants can be obtained by physical, chemical, or biological process, by process changes or other means except as described by 40 CFR 403.
- ~~76.74.~~ Pretreatment Equipment. Any equipment, structures or devices used for the treatment or flow limitation of industrial wastewater prior to discharge to sewerage facilities.
- ~~77.75.~~ Pretreatment Requirements. Any substantive or procedural requirement related to pretreatment imposed on a user, other than a national pretreatment standard.
- ~~78.76.~~ Prohibited Discharges. Any prohibitions against the discharge of certain substances; these prohibitions appear in Article 5.
- ~~79.77.~~ Public Agency. The State and any city, county, district, agency, other local authority or public body of or within this state.
- ~~80.78.~~ Rainwater. Water resulting from precipitation which directly falls upon any surface.Regulatory Agencies. Those Agencies having jurisdiction over the operation of ~~the~~ IRWD, including, but not limited to, the following:
- a. United States Environmental Protection Agency (EPA).
  - b. State Water Resources Control Board (SWRCB).
  - c. Regional Water Quality Control Board (RWQCB).
  - d. South Coast Air Quality Management District (SCAQMD).
  - ~~e. Department of Health Services (DOHS).~~
  - ~~f.e.~~ California Environmental Protection Agency (Cal-EPA).
- ~~82.80.~~ Representative Sample Point. A location set forth in the user's wastewater discharge permit or other control mechanism from which wastewater can be collected that is as nearly identical in content and consistency as possible to that of the entire flow of wastewater being sampled. For categorical users, this point shall be at the end of each regulated process, and for all other users shall be determined on a case-by-case basis.
- ~~83.81.~~ Resource Conservation and Recovery Act (RCRA). The RCRA Act of 1976 (42 U.S.A. 6901, et seq.) to implement the conservation and recovery of used or spent resources and as amended.
- ~~84.82.~~ Routine Sampling. Any sampling conducted by ~~the IRWD~~IRWD to verify compliance of a user's discharge to sewerage facilities. Sampling may consist of either grab or composite samples or a combination of both.



~~85-83.~~ Sampling Equipment. Equipment or structure provided at the user's sole expense for ~~the IRWD~~IRWD or the user to measure and record wastewater constituents, collection of samples or provide access to plug or terminate the discharge.

~~86-84.~~ Scum. Any layer of matter or combination of air and matter that forms on or rises to the surface of a liquid or body of water.

~~87-85.~~ Sewage. Wastewater.

~~88-86.~~ Sewerage Facilities. Any and all systems used for collecting, conveying, pumping, reclamation, recycling, reuse, storage, transportation, treatment or disposal of sewage, industrial waste of a liquid nature, wastewater, sludge or biosolids that is owned and/or operated by ~~the IRWD~~IRWD, SOCWA or other public agency which is tributary to systems operated by ~~the IRWD~~IRWD or SOCWA. This definition includes, but is not limited to, publicly owned treatment works (POTW's) as defined by Section 212 of the Act (33 U.S.C. Section 1292), public sewers, trunk lines, sewer mains, wet wells, treatments plants and ocean outfalls which are owned by ~~the IRWD~~IRWD or SOCWA.

~~89-87.~~ Shall. Mandatory.

~~90-88.~~ Significant Industrial User (SIU). A user as defined by 40 CFR 403, except as provided in paragraphs c and d of this definition, which includes the following:

- a. An industrial users subject to categorical pretreatment standards; or
- b. An industrial user that: discharges an average of twenty-five (25,000) gallons per day or more of process wastewater to ~~the IRWD~~IRWD or SOCWA (excluding sanitary, noncontact cooling water, and boiler blowdown wastewater); contributes a process wastestream which makes up five percent (5%) or more of the average dry weather hydraulic or organic capacity of IRWD's or SOCWA's sewerage facilities; or is designated as such by ~~the IRWD~~IRWD on the basis that the industrial user has a reasonable potential for adversely affecting ~~the IRWD~~IRWD's or SOCWA's operation or for violating any pretreatment standard or requirement.
- c. ~~The IRWD~~IRWD may determine that an industrial user subject to categorical pretreatment standards is a Non-Significant Categorical Industrial User (NSCIU) rather than a Significant Industrial User on a finding that the industrial user never discharges more than 100 gallons per day (gpd) of total categorical wastewater (excluding sanitary, noncontact cooling and boiler blowdown wastewater, unless specifically included in the Pretreatment Standard) and the following conditions are met:
  - i. The industrial user, prior to IRWD's finding, has consistently complied with all applicable categorical pretreatment standards and requirements;

- ii. The industrial user annually submits the certification statement required in 40 CFR 403.12(q) together with any additional information necessary to support the certification statement; and
  - iii. The industrial user never discharges any untreated concentrated wastewater.
- d. Upon a finding that an industrial user meeting the criteria in paragraph b above of this definition has no reasonable potential for adversely affecting IRWD's operation or for violating any pretreatment standard or requirement, IRWD may at any time, on its own initiative or in response to a petition received from an industrial user, and in accordance with 40 CFR 403.8(f)(6), determine that such industrial user should not be considered a significant industrial user. Significant Non-Compliance. A violation by a SIU (or any IU which violates paragraphs c, d or h of this definition) as described in 40 CFR 403.8(f)(2)(viii)(A-H) which meets one or more of the following criteria:
- a. Chronic violations of wastewater discharge limits, defined here as those in which sixty-six percent (66%) or more of all of the measurements taken for the same pollutant parameter during a six (6) month period exceed (by any magnitude) a numeric pretreatment standard or requirement, including instantaneous limits, as described in 40 CFR 403.3(l);
  - b. Technical Review Criteria (TRC) violations, defined here as those in which thirty-three percent (33%) or more of all of the measurements taken for the same pollutant parameter during a six (6) month period equals or exceeds the product of the numeric pretreatment standards or requirement including instantaneous limits, as described in 40 CFR 403.3(l) multiplied by the applicable TRC (TRC = 1.4 for BOD, TSS, fats, oil and grease, and 1.2 for all other pollutants except pH);
  - c. Any other violation of a pretreatment standard or requirement as defined in 40 CFR 403.3(l) (daily maximum, long-term average, instantaneous limit, or narrative standard) that IRWD determines has caused, alone or in combination with other discharges, interference or pass through, including endangering the health of IRWD or SOCWA personnel or the general public;
  - d. Any discharge of a pollutant that has caused imminent endangerment to human health, welfare or to the environment or has resulted in ~~the~~ IRWD/IRWD's exercise of its emergency authority under 40 CFR 403.8(f)(1)(vi)(B) to halt or prevent such a discharge;
  - e. Failure to meet, within ninety (90) days after the scheduled date, a compliance schedule milestone contained in a wastewater discharge permit, other control mechanism or enforcement order for starting construction, completing construction, or attaining final compliance;
  - f. Failure to provide within forty-five (45) days after the due date, required reports, including, but not limited to baseline monitoring reports, 90-day

compliance reports, periodic self-monitoring reports and reports on compliance with compliance schedules;

- g. Failure to accurately report noncompliance;
- h. Any other violation or group of violations, which may include a violation of Best Management Practices, which IRWD determines will adversely affect the operation or implementation of the local pretreatment program.

~~92.90.~~ Sludge. Any solid, semi-solid or liquid decant, supernate, or supernate from an industrial manufacturing process, utility service or pretreatment equipment.

~~93.91.~~ Slug Discharge. Any discharge of a non-routine, episodic nature, that may exceed the standards and prohibitions contained in Article 5 of this ordinance and significantly exceeds the usual industrial flow or pollutants loading, either mass or concentration including but not limited to an accidental spill or a non-customary batch discharge, which has a reasonable potential to cause interference or pass through, or in any other way violate the regulations, local limits or permit conditions associated with sewerage facilities.

~~94.92.~~ Solvent. Any substance that is used to dissolve another substance in it.

~~95. South Orange County Wastewater Authority. The Joint Powers Authority (JPA) which is formed by the participating MAs. The MAs individually and/or collectively use SOCWA's sewerage facilities. SOCWA is the holder of the NPDES permits, which states the pretreatment and waste discharge requirements for the sewerage facilities.~~

~~96.93.~~ Spent Solutions. Any concentrated industrial wastewater.

~~97.94.~~ Spill Containment. Any protection equipment provided and installed at the user's sole expense to prohibit the discharge of non-compatible wastes to sewerage facilities.

~~98.95.~~ Standard Methods. Procedures described in the current edition of Standard Methods for the Examination of Water and Wastewater, as published jointly by the American Public Health Association, the American Water Works Association and the Water Environment Federation.

~~99.96.~~ Stormwater. Any flow occurring during or ~~immediately~~immediately following any form of natural precipitation, ~~including snowmelt,~~ which runs off, or travels over the ground surface to a drainage area or channel or drains uncontrolled to a municipal storm drain system for disposal tributary to a river, stream, lake or creek and ultimately to the Pacific Ocean.

~~100.97.~~ Street Drainage. Water resulting from surface runoff generated by rainwater, stormwater or other sources.

~~101.98.~~ Subsurface Drainage. A method of draining that is situated under the ground (e.g., leachate control system).

- ~~402.99.~~ Surface Runoff. Runoff other than that which is caused by rainfall, stormwater, or street drainage (e.g., car wash runoff, washdown runoff) originating from a user.
- ~~403.100.~~ Total Organic Carbon (TOC). The measure of total organic carbon in domestic or other wastewater as determined by the appropriate testing procedure.
- ~~404.101.~~ Total Suspended Solids. Any insoluble material contained as a component of wastewater and capable of separation from the liquid portion by laboratory filtration as determined by the appropriate testing procedures and expressed in terms of milligrams per liter (mg/L).
- ~~405.102.~~ Toxic Pollutant. Any pollutant or combination of pollutants listed as toxic by the EPA under the provisions of Section 307(a) of the Act or other acts or that can harm human health, aquatic life or the biological treatment processes.
- ~~406.103.~~ Unpolluted Water. Water to which no constituent has been added either intentionally or accidentally.
- ~~407.104.~~ Upset. Any upset that meets the criteria as described in 40 CFR 403.
- ~~408.105.~~ User. Any person or entity which discharges or causes a discharge of wastewater to a sewerage facility, as defined by EPA regulations. May be interchangeable with discharger, indirect discharger, industrial user, permittee or person.
- ~~409.106.~~ Volatile. Natural (plant or animal origin) or synthetic substances that is capable of being evaporated or changed to vapor at relatively low temperatures.
- ~~410.107.~~ Waste. Sewage and any other waste substances, whether liquid, solid, gaseous or radioactive.
- ~~411.108.~~ Waste Manifest. A receipt which is retained by the generator of hazardous wastes as required by the State or the United States Government pursuant to RCRA or the California Hazardous Materials Act or that receipt which is retained by the generator for recyclable wastes or liquid non-hazardous wastes as required by ~~the IRWD~~IRWD.
- ~~412.109.~~ Wastewater. Liquid and water-carried industrial wastes and sewage from residential dwellings, commercial buildings, industrial and manufacturing, and institutions, whether treated or untreated, which are discharged or permitted to enter sewerage facilities.-
- ~~413.110.~~ Wastewater Constituents and Characteristics. The individual chemical, physical, bacteriological, radiological, volume, flow rate and such other parameters that serve to define, classify or measure the quality and quantity of wastewater.
- ~~414.111.~~ Wastewater Discharge (WD) Permit. The form of authorization from ~~the IRWD~~IRWD issued to an industrial user for the discharge of wastewater. This

wastewater discharge permit sets forth the limits and conditions under which the industrial user ~~shall be able~~ will be allowed to discharge wastewater into sewerage facilities.

### 2.03 ABBREVIATION

A. The following abbreviations shall have the designated meanings:

1. "BAT" Best Available Technology
2. "BMP" Best Management Practice
3. "BMR" Baseline Monitoring Report
4. "BOD" Biochemical Oxygen Demand
5. "BPT" Best Practicable Technology
6. "CA" Control Authority
7. "CAR" Company Authorized Representative
8. "CFR" Code of Federal Regulations
9. "CIU" Categorical Industrial User
10. "COD" Chemical Oxygen Demand
11. "CWF" Combined Wastestream Formula
12. "DO" Dissolved Oxygen
13. "EPA" Environmental Protection Agency
14. "ERP" Enforcement Response Plan
15. "FOG" Fats, Oils and Grease
- ~~16. "FROG" Fats, Roots, Oil and Grease~~
- ~~17.~~ 16. "gpd" Gallons per Day
- ~~18.~~ 17. "gpm" Gallons per Minute
- ~~19.~~ 18. "IU" Industrial User
- ~~20.~~ 19. "IRWD" Irvine Ranch Water District
- ~~21.~~ 20. "lb/day" Pounds Per Day
- ~~22.~~ 21. "JPA" Joint Powers Authority

<del>23-22.</del> "LEL"	Lower Explosive Limit
<del>24-23.</del> "MA"	Member Agency
<del>25-24.</del> "MGD"	Million Gallons Per Day
<del>26-25.</del> "MSDS"	Material Safety Data Sheet
<del>27-26.</del> "NAICS"	North America Industry Classification System
<del>28-27.</del> "NPDES"	National Pollutant Discharge Elimination System
<del>29-28.</del> "NSCIU"	Non-Significant Categorical Industrial User
<del>30-29.</del> "O&G"	Oil and Grease
<del>31-30.</del> "PCBs"	Polychlorinated Biphenyls
<del>32-31.</del> "POTW"	Publicly Owned Treatment Works
<del>33-32.</del> "PSES"	Pretreatment Standards for Existing Sources
<del>34-33.</del> "PSNS"	Pretreatment Standards for New Sources
<del>35-34.</del> "RCRA"	Resource Conservation and Recovery Act
<del>36-35.</del> "RWQCB"	Regional Water Quality Control Board
<del>37-36.</del> "SOCWA"	South Orange County Wastewater Authority
<del>38-37.</del> "SIU"	Significant Industrial User
<del>39-38.</del> "SNC"	Significant Non-Compliance
<del>40-39.</del> "SWRCB"	State Water Resources Control Board
<del>41-40.</del> "TDS"	Total Dissolved Solids
<del>42-41.</del> "TOC"	Total Organic Carbon
<del>43-42.</del> "TOMP"	Toxic Organic Management Plan
<del>44-43.</del> "TRC"	Technical Review Criteria
<del>45-44.</del> "TSS"	Total Suspended Solids
<del>46-45.</del> "TTO"	Total Toxic Organics
<del>47-46.</del> "U.S.C."	United States Code
<del>48-47.</del> "mg/L"	Milligrams per Liter (0.001)

<del>49-48.</del> "ug/L"	Microgram per Liter	(0.000001)
<del>50-49.</del> "ng/L"	Nanograms per Liter	(0.000000001)
<del>51-50.</del> "pg/L"	Picograms <del>pre-per</del> Liter	(0.000000000001)

**ARTICLE 3  
AUTHORITIES AND POWERS**

**3.01 AUTHORITY**

- A. ~~The~~ IRWD is regulated by Agencies of the United States Federal Government and the State under provisions of federal and state law. Federal law requires SOCWA and ~~the~~ IRWD and the state grants ~~the~~ IRWD the authority to regulate and/or prohibit the discharge of any waste, directly or indirectly, to SOCWA's or IRWD's sewerage facilities by adoption of ordinances, resolutions, ~~and~~ issuance of wastewater discharge permits or other control mechanisms, ~~the discharge of any waste, directly or indirectly, to SOCWA's or the IRWD's sewerage facilities~~. That authority includes, but is not limited to, the right to establish local limits, conditions, prohibitions, flow rates, ~~;~~ to prohibit flows discharged to ~~the~~ IRWD's sewerage facilities, ~~;~~ and to enforce federal, state and local requirements. This may require the implementation of compliance schedules for the installation of flow monitoring equipment by users and for ~~the~~ IRWD to take all actions necessary to enforce its authority, whether within or outside IRWD's service area, including those users that are tributary to ~~the~~ IRWD or within areas for which ~~the~~ IRWD has contracted to provide sewerage facility services.
  
- B. ~~The IRWD~~ IRWD has the authority under California Health and Safety Codes 5471 and 5474 to prescribe, revise, and collect all regulatory fees and to charge for services and sewerage facilities furnished by ~~the IRWD~~ IRWD and/or SOCWA either within or without its service area.
  
- C. Administration and enforcement of the pretreatment program may be carried out on a daily basis by any individual and/or combination of IRWD personnel as granted by an interjurisdictional agreement under the oversight of SOCWA. However, SOCWA retains the authority to assume, at any time, administrative and enforcement powers of the pretreatment program requirements within ~~the IRWD~~ IRWD jurisdiction.
  
- D. ~~The~~ IRWD shall have the authority to seek enforce compliance with 40 CFR 403, its NPDES permit and the provisions of this ordinance by, but not limited to, the following:
  - 1. Issuinge WD permits.
  - 2. Requiring e-the installation of pretreatment equipment.
  - 3. Requiringe the installation of monitoring and/or sampling equipment and/or structures.
  - 4. Requiringe self-monitoring and reporting of the user's discharge.

5. Requiringe the implementation of spill containment plans.

### 3.02 **DELEGATION OF AUTHORITY**

Whenever any authority or power is granted to or a duty imposed upon the General Manager, that authority or power may be exercised or that duty may be performed by a person authorized by the General Manager. **ENFORCEMENT POWERS**

- A. Enforcement action against a user for being in non-compliance with ~~the any~~ provision of this ordinance may include, but is not limited to, the following:
  1. Issuing a Warning Notice of Non-compliance letter.
  2. Issuing a notice of non-compliance (NON) form.
  3. Issuing a notice of violation (NOV) form.
  4. Issuing an administrative order (AO) which may also include, but ~~are is~~ not limited to, the following types of orders:
    - a. Probation Order (PO)
    - b. Show Cause Order (SCO)
    - c. Cease and Desist Order (CDO)
  5. Petitioning the courts for injunction or civil penalties.
  6. Signing criminal complaints.
  7. Suspension or revocation of an issued wastewater discharge permit or other control mechanism.
  8. Termination of services.
  9. Bringing Aa administrative complaints.
- B. The ~~issuance~~-initiation of an enforcement action shall not be a bar against, or a prerequisite for, taking any other enforcement action against the user.

## ARTICLE 4 ADMINISTRATION

### 4.01 **BY IRVINE RANCH WATER DISTRICT (IRWD)**

- A. ~~The IRWD~~IRWD may shall implement pretreatment and source control programs in accordance with federal, state, and SOCWA regulations, the provisions of this ordinance, and any interjurisdictional agreements.



- B. If ~~the IRWD~~IRWD desires to perform its own pretreatment and source control program, it shall do so pursuant to the interjurisdictional agreement with SOCWA, under the oversight of SOCWA.
- C. ~~The IRWD~~IRWD, when operating its own pretreatment and source control program, shall keep SOCWA apprised of all activities on a regular and consistent basis. This may be accomplished by, but not limited to, correspondence, meetings and submittal of periodic reports.
- D. ~~The IRWD~~IRWD shall have the authority to use fees and charges provided for within this ordinance when a user is in non-compliance.
- E. ~~The IRWD~~IRWD shall provide SOCWA any and all information and submittals by users for review and central filing.
- F. ~~The IRWD~~IRWD, which ~~may~~operates its own sewerage facilities, shall coordinate with SOCWA ~~the to~~establishment of technically-technically-based local limits. These limits shall be established in accordance with section 4.02 H. of this ordinance. These limits are to ensure that any user's effluent that is discharged to sewerage facilities does not cause, ~~but is not limited to, any of~~ the following:
  - 1. Upset, pass through or interference of the biological treatment process.
  - 2. Upset, pass through or interference of the sludge digestion process.
  - 3. Reclaimed or recycled water or generated biosolids to be unable to meet regulatory standards for beneficial reuse or unlimited distribution as defined by regulatory agencies.
  - 4. Violation of any IRWD or SOCWA NPDES permit limitations.
  - 5. Pass-through or interference causing ~~the IRWD~~IRWD or SOCWA to violate any discharge limits of the SOCWA Ocean Outfalls.

**4.02 ~~402~~ BY SOCWA**

- A. SOCWA has the authority to implement pretreatment and source control programs in accordance with federal and state regulations ~~and the provisions of this ordinance, SOCWA's pretreatment and source control ordinance and interjurisdictional agreements with the MAs.~~
- B. SOCWA has the authority to approve all forms used in the pretreatment and source control program.
- C. SOCWA has the authority to, at any time, assume administration and enforcement of this ordinance within the service area of ~~the IRWD~~IRWD.
- D. SOCWA has the authority to locate and terminate any non-compliant discharge that is not discontinued, upon notification that a non-compliant discharge is occurring.

- E. SOCWA has the authority to review all applications, wastewater discharge permits, other control mechanisms and any enforcement actions that have been taken.
- F. SOCWA has the authority to review all ordinances pertaining to pretreatment and source control programs before adoption or implementation by ~~the IRWD~~IRWD.
- G. SOCWA has the authority to audit ~~the IRWD~~IRWD when performing its own pretreatment and source control program.
- H. SOCWA shall oversee the establishment of technically based local limits for ~~the IRWD~~IRWD. A review of the local limits may be conducted every five years or in conjunction with the renewal of SOCWA's NPDES Permits.

#### **4.03 PROGRAM ENFORCEMENT**

- A. ~~The~~IRWD shall have first priority to enforce the regulations contained within this ordinance in accordance with, but not limited to, the following:
  - 1. SOCWA shall conduct the pretreatment and source control program for ~~the~~IRWD unless otherwise directed by the interjurisdictional agreement with ~~the~~IRWD.
  - 2. When ~~the~~IRWD is performing its own program it shall inform SOCWA of all program activity.
  - 3. ~~The~~IRWD when performing its own program shall conduct routine sampling of permitted users for constituents the industry must sample and analyze for as part of their self-monitoring program, and inform SOCWA of such activity.

#### **4.04 APPLICATIONS**

All applications for wastewater discharge permits ~~may~~will be reviewed by ~~the~~IRWD and SOCWA.

#### **4.05 WASTEWATER DISCHARGE (WD) PERMITS**

- A. All proposed WD Permits ~~may~~will be reviewed by ~~the IRWD~~IRWD and SOCWA before being issued to the user.
- B. All issued WD Permits shall be signed, identified and/or numbered by ~~the IRWD~~IRWD or SOCWA.

#### **4.06 INSPECTIONS, MONITORING AND ENFORCEMENT**

- A. SOCWA shall be notified by ~~the IRWD~~IRWD when inspecting, monitoring, or enforcement activities will or have already occurred. This may be done by, but not limited to, the following:
  - 1. Phone contact or correspondence.
  - 2. Submittal of written schedule reports or status reports.

- B. Emergency enforcement actions by ~~the IRWD~~IRWD shall be reported to SOCWA by phone within twenty-four (24) hours during weekdays and within seventy-two (72) hours during weekends, and by written report within five (5) days of their notice to the user.

#### 4.07 FUNDING

- A. ~~Upon Subject to~~ review by SOCWA, ~~the~~IRWD may establish a schedule of wastewater discharge permit application fees, annual fees, sample analysis charges, and any other fees or charges required to recover reasonable costs of implementing a pretreatment and source control program.
- B. ~~The industrial user shall pay IRWD for all c~~Costs incurred by ~~the IRWD~~IRWD for its pretreatment activity may be collected by, ~~but not limited to~~upon invoice, ~~ing directly to the industrial user.~~

#### 4.08 APPEALS

- A. ~~The~~IRWD shall have first priority to handle appeals in accordance with the provisions of this ordinance.
  - 1. Appeals ~~of a~~ staff action shall be directed to the General Manager.
  - 2. Appeals ~~of a~~ the General Manager's action shall be directed to the Board.
  - 3. Actions by the Board shall be final.
- B. SOCWA shall have the authority to handle appeals where ~~the IRWD~~IRWD ~~lacks sufficient~~has no jurisdiction, or fails to enforce against a user in accordance with the provision of this ordinance or the interjurisdictional agreements.

### ARTICLE 5 GENERAL DISCHARGE PROHIBITIONS AND LIMITATIONS

#### 5.01 PROHIBITED DISCHARGES

- A. These prohibitions apply to all users of sewerage facilities whether or not they are subject to categorical pretreatment standards or any other national, State or local pretreatment standards or requirement.
- B. No user shall discharge directly or indirectly a quality or quantity of wastes, solids, viscous substances, wastewater or pollutants to sewerage facilities, either alone or by interaction with other substances, which cause or will cause:
  - 1. Obstruction of flow.
  - 2. Pass through or interference.
  - 3. Inhibition of biological activity.
  - 4. The final effluent to fail a toxicity test.

5. Corrosive or physical structural damage to sewerage facilities.
6. Danger to life and/or safety of any person.
7. Impairment of the effective maintenance or operation of any sewerage facility.
8. A fire or explosion hazard based upon a closed cup flashpoint of less than 140 degrees Fahrenheit (60°C) using the test method specified in 40 CFR 261.21.
9. The presence of toxic gases, vapors, fumes, or poisonous, noxious or malodorous gas producing substances that may cause acute worker health and safety problems.
10. Any product of any sewerage facility including, but not limited to the final effluent ,biosolids, residue, sludge, or scum to be unsuitable for reclamation, reuse, or disposal.
11. Discoloration or any other condition which affects the quality of the final effluent in such a manner that discharge requirements established by regulatory agencies cannot be met.
12. Conditions which violate any statute, rule, regulation, or ordinance of any public agency or regulatory agency having jurisdiction over the discharge of wastewater through sewerage facilities.
13. The discharge of petroleum oil, nonbiodegradable cutting oil, or products of mineral oil origin, which cause interference or pass through.

#### **5.02 PROHIBITION ON DILUTION**

Except where expressly authorized to do so by an applicable standard, no user shall discharge directly or indirectly to sewerage facilities an increase in the use of water to attempt to dilute a waste being discharged, as a partial or complete substitute for treatment to achieve compliance with this ordinance, a wastewater discharge permit, other control mechanism or to establish an artificially high flow rate for mass emission rates.

#### **5.03 PROHIBITION ON BIOHAZARDOUS WASTE**

No user shall discharge directly or indirectly to sewerage facilities a biohazardous waste without rendering it non-biohazardous prior to discharge if the biohazardous waste is deemed to pose a threat to public health and safety or will result in any violation of applicable waste discharge requirements.

#### **5.04 PROHIBITION ON TOXIC OR HAZARDOUS WASTE**

No user shall discharge directly or indirectly to sewerage facilities, any substance that is defined as a toxic or hazardous waste by regulatory agencies, except those wastes which meet the requirements of 40 CFR 403.

**5.05 PROHIBITION ON WARFARE AGENTS**

No user shall discharge directly or indirectly to sewerage facilities any radiological, chemical, or biological warfare agent.

**5.06 LIMITATIONS ON DISPOSAL OF SPENT SOLUTIONS AND SLUDGES**

- A. Any spent solutions, sludges, and/or other wastes generated by the user that are a hazardous waste and not treated on site shall be hauled by a registered hazardous waste transporter. The user shall complete and maintain a hazardous waste manifest that documents the removal and transport of the waste.
- B. All hazardous waste manifests shall be retained for a minimum of three (3) years and shall be made available to ~~the IRWD~~IRWD upon request. ~~The IRWD~~IRWD may require a longer period of retention if litigation is being considered.
- C. No user shall batch dump to sewerage facilities without written approval from ~~the IRWD~~IRWD.

**5.07 LIMITATIONS ON THE USE OF GRINDERS**

Wastes from industrial or commercial grinders shall not be discharged into a sewerage facility, except wastes generated in packing or preparing food or food products on a case by case ~~bases-basis~~ as approved by ~~the IRWD~~IRWD. Such grinders must shred the waste to a degree that all particles will be carried freely under normal flow conditions prevailing in the sewerage facilities.

**5.08 LIMITATION ON RAINWATER, STORMWATER, AND STREET DRAINAGE**

No user shall discharge or cause to be discharged directly or indirectly into sewerage facilities any rainwater, stormwater, or street drainage that exceeds the first one-tenth (1/10) of an inch of precipitation from any storm event.

**5.09 LIMITATIONS ON GROUNDWATER AND SUBSURFACE DRAINAGE**

- A. Groundwater and subsurface drainage shall not be discharged directly or indirectly to sewerage facilities except as provided herein.
- B. IRWD may approve the discharge of such water, by wastewater discharge permit or other control mechanism only, when no alternate method of disposal is reasonably available or to mitigate an environmental risk or health hazard.
- C. The discharge of such water shall require the following:
  - 1. A Class IV Special Wastewater Discharge Permit or other control mechanism issued by ~~the IRWD~~IRWD, and
  - 2. Documentation from the user or user's consultant that all other alternate methods of disposal have been exhausted, and
  - 3. User shall pay all applicable fees and charges and shall meet any other conditions as required by ~~the IRWD~~IRWD.

**5.10 LIMITATIONS ON TRUCKED OR HAULED WASTES**

- A. No user shall discharge trucked or hauled wastes directly or indirectly to sewerage facilities without written approval from ~~the IRWD~~IRWD and SOCWA. Written approval may be in the form of an individual special wastewater discharge permit or other control mechanism.
- B. No user shall transport waste from one location to another for the purpose of treating or discharging it directly or indirectly to sewerage facilities without written approval from ~~the IRWD~~IRWD and SOCWA. Written approval may be in the form of an individual special wastewater discharge permit or other control mechanism.

**5.11 LIMITATIONS ON POINT OF DISCHARGE**

No user shall discharge any wastewater directly or indirectly into a manhole or other opening in a sewerage facility other than through an approved building sewer unless approved in writing by ~~the IRWD~~IRWD.

**5.12 LIMITATIONS ON RADIOACTIVE WASTES**

- A. No user shall discharge directly or indirectly to sewerage facilities any radioactive waste except as ~~provided herein~~follows:
  - 1. When the user is authorized to use radioactive materials by the ~~California Department of Public Health~~ California State Department of Health or other governmental agency empowered to regulate the use of radioactive materials, and
  - 2. When the waste is discharged in strict conformity with current California Radiation Control Regulations (Cal. ~~Adm.~~Code Regs. Title 17) for safe disposal, and
  - 3. When the user is in compliance with all other rules and regulations of all other applicable regulatory agencies.

**5.13 LIMITATIONS ON UNPOLLUTED WATER**

- A. Unpolluted water such as deionized, steam waste, distilled, single pass cooling water in excess of laboratory usage, blow-down or bleed water from cooling towers, or other evaporating coolers, or commercial swimming pool water drainage shall not be discharged directly or indirectly to sewerage facilities except as provided herein.
- B. ~~The IRWD~~IRWD may approve the discharge of such water when no alternate method of disposal or reuse is reasonably available or there is need to mediate an environmental risk or health hazard.
- C. The discharge of such water shall require the following:
  - 1. A Class IV Special Wastewater Discharge Permit or other control mechanism, and

2. Documentation from the user or user's consultant that all other alternate methods of disposal have been exhausted, and
3. User shall pay all applicable fees and charges and shall meet any other conditions as required by ~~the IRWD~~IRWD.

#### **5.14 MASS EMISSION LIMIT DETERMINATION**

- A. Mass emission limits for non-compatible and compatible wastes that are present or anticipated in the user's wastewater discharge may be set for each user and made an applicable part of each user's wastewater discharge permit or other control mechanism. These limits shall be based on Table I, local limits or national pretreatment standards and the user's average daily wastewater discharge for the past three (3) years, the most recent representative data, or other data acceptable by ~~the IRWD~~IRWD.
- B. To verify the user's operating data, the user may be required to submit an inventory of all wastewater streams and production data.
- C. ~~The IRWD~~IRWD may revise local limit concentration limits or mass emission limits previously established in the user's wastewater discharge permit or other control mechanism at any time, based on current and/or anticipated operating data, the ability to meet NPDES Limits, and/or changes in the requirements of regulatory agencies.
- D. The increased use of water to establish an artificially high flow rate data base for mass emission limit determinations is prohibited.

#### **5.15 WASTEWATER STRENGTHS AND CHARACTERISTICS**

- A. No user shall discharge wastewater directly or indirectly to sewerage facilities with the following strengths and characteristics:
  1. Having a temperature higher than 140 degrees Fahrenheit (60 degrees Centigrade) or which causes the temperature at the influent to a wastewater treatment plant to exceed 104 degrees Fahrenheit (40 degrees Centigrade).
  2. Containing substances that may precipitate, solidify, or become viscous at temperatures between 50 degrees Fahrenheit (10 degrees Centigrade) and 104 degrees Fahrenheit (40 degrees Centigrade).
  3. Containing materials which will readily settle or cause an obstruction to flow in sewerage facilities or be detrimental to the proper operation of a sewerage facility. These materials may include, but are not limited to, asphalt, concrete, dead animals, offal ashes, sand, mud, straw, industrial process shavings, metal, glass, rags, feathers, tar, plastics, wood, whole blood, bones, hair, coffee grounds, egg shells, flashings, diatomaceous earth, seafood shells, and paper products not intended for use in sewerage facilities.
  4. Producing a gaseous mixture that is ten percent (10%) or greater of the lower explosive limit (LEL). Prohibited materials include, but are not limited to, gasoline, kerosene, naphtha, benzene, toluene, xylene, ethers, ketones, and alcohols.

5. Having a pH less than 5.0 or greater than 11.0.
6. Containing recognizable portions of human or animal anatomy. Containing excessive flow, constituents or other materials, including but not limited to, biological oxygen demand, chemical oxygen demand, total organic carbon, toxic pollutants, suspended solids, grease and oil of animal or vegetable origin total dissolved solids, detergents, surface active agents, phenolic compounds or other substances that are released in a discharge at a flow rate and/or concentration which will cause problems, pass-through or interference with sewerage facilities.
8. Containing PCBs in excess of 0.01 mg/L as a daily maximum.
9. Containing pesticides in excess of 0.01 mg/L as a daily maximum.
10. Violation of any applicable national pretreatment standards, state standards, or other local regulations covering wastewater disposal.

**5.16 SPECIFIC LOCAL LIMITS**

- A. IRWD in coordination with SOCWA is authorized to establish local limits pursuant to 40 CFR 403.
- B. No user shall discharge directly or indirectly a quality or quantity of wastes or wastewater containing toxic pollutants, non-compatible or compatible wastes in excess of Table I, Specific Local Limits. All local limits for the metal pollutants are for the “total metal” amount analyzed, unless indicated otherwise.

Table I

Specific Local Limits

Pollutant	Limit (mg/L)
Arsenic	3.4
Cadmium	0.93
Chromium	4.9
Copper	7.2
Lead	4.9
Mercury	0.19
Nickel	9.5
Silver	2.8
Zinc	7.9
Cyanide	4.3
Oil and Grease	300

- C. Local limits are subject to more stringent standards as established by national pretreatment standards. Local limits are deemed to be pretreatment standards for the purposes of Section 307(d) of the Act, and are enforceable under Section 309 of the Act, potentially subjecting an IU to a penalty of \$25,000 per day for each violation.
- D. ~~The IRWD~~IRWD may place more stringent standards within any wastewater discharge permit or other control mechanism issued to a user at any time, based on current and/or



anticipated operating conditions presented in the wastewater discharge permit application, the ability to meet NPDES permit limits, and/or changes in the requirements of regulatory agencies.

- E. ~~The IRWD~~IRWD may develop Best Management Practices (BMPs) for use in any wastewater discharge permit or other control mechanism to implement local limits and the requirements in this ordinance.

#### 5.17 **STATE REQUIREMENTS**

Upon the adoption of any state requirements on user discharges that are more stringent than federal requirements or the limitations contained in this ordinance, that state standard shall then immediately supersede the federal standard and the limitations of this ordinance.

#### 5.18 **FEDERAL REQUIREMENTS**

- A. Upon adoption of a national pretreatment standard more stringent than those contained in this ordinance, the federal standard shall immediately supersede the limitations listed in this ordinance and the affected significant industrial users shall be notified of the new standards and applicable reporting requirements.
- B. The significant industrial user shall comply with the national pretreatment standard within the time provided in the federal regulations that establish such standards even if their wastewater discharge permit has not yet been modified to incorporate the new requirement or standards.
- C. The significant industrial user shall comply with any applicable requirements under Sections 204(b) and 405 of the Act and Subtitles C and D of the RCRA.

### **ARTICLE 6 WASTEWATER DISCHARGE PERMITS**

#### 6.01 **WRITTEN AUTHORIZATION**

- A. Users may be required to obtain written authorization to use sewerage facilities. This written authorization may be in the form of a wastewater discharge permit or other control mechanism issued by ~~the~~IRWD. No vested right shall be given or be granted by issuance of a wastewater discharge permit or other control mechanism as provided for in this ordinance.
- B. When written authorization is granted, all the types of wastewater discharge permits and any other control mechanisms shall be expressly subject to all provisions of this ordinance and all other regulations, charges for use and fees established by ~~the~~IRWD. The requirements contained in wastewater discharge permits or other control mechanisms are subject to enforcement under this ordinance and under state and federal law.

- C. All users that have obtained written authorization shall discharge their process wastewater only as provided for by their wastewater discharge permit or other control document.
- D. Compliance with wastewater discharge permit or other control mechanism provisions does not relieve the user from complying with any other applicable federal, state or local requirement.

**6.02 TYPES OF WASTEWATER DISCHARGE PERMITS**

- A. The wastewater discharge permit may be in one of four (4) types and is dependent upon process, volume and pollutant characteristics of the users discharge. The four types of wastewater discharge permits are:
  - 1. Class I – Wastewater Discharge (WD) Permit.
  - 2. Class II – Wastewater Discharge (WD) Permit.
  - 3. Class III – Wastewater Discharge (WD) Permit.
  - 4. Class IV – Special Wastewater Discharge (SWD) Permit.

**6.03 TRANSFER PROHIBITION**

Wastewater discharge permits issued under this ordinance are for a specific user, for a specific operation at a specific location. Wastewater discharge permits shall not be transferred for an operation at a different location.

**6.04 CHANGE OF OWNERSHIP**

- A. Upon the sale or transfer of ownership of any business operating under a wastewater discharge permit issued by ~~the IRWD~~IRWD, the user shall notify ~~the IRWD~~IRWD in writing prior to the change of ownership. The successor owner shall be required to apply for a new wastewater discharge permit prior to the sale or transfer of ownership.
- B. In the event that the original owner fails to notify ~~the IRWD~~IRWD of the sale or transfer of ownership than said original owner may be jointly liable for any charges incurred by the new owner.
- C. This does not relieve the new owner of any liability for non-compliance with any federal, state, or local regulations or the provisions of this ordinance.

**6.05 EXCESS CAPACITY REGULATORY FEE**

New users or existing users that expand operations that require substantial sewerage facility capacity may be subject to an excess capacity sewerage facility regulatory fee in an amount and method to be solely determined by ~~the IRWD~~IRWD on a case-by-case basis.

**6.06 OUT OF SERVICE AREA WASTEWATER DISCHARGE PERMITS**

Wastewater discharge permits for users located outside of ~~the IRWD~~IRWD's service area but tributary to ~~the IRWD~~IRWD's sewerage facilities shall only be issued after approval by ~~the~~

~~IRWD~~IRWD. Inspection and sampling of the user's discharge to determine compliance with discharge regulations will be made under a coordinated plan developed by SOCWA, ~~the IRWD~~IRWD and the local sewerage agency. The more stringent discharge regulations and effluent limitations of affected agencies shall apply to the user. The fees for use shall be determined by ~~the IRWD~~IRWD and set forth in an interjurisdictional agreement.

#### **6.07 REQUIRED INFORMATION**

- A. To provide for the equitable use of sewerage facilities, and as a condition of continued usage of the sewerage system, the upon request by IRWD, shall have the right to require a user ~~to shall~~ provide all information necessary to maintain compliance with the provisions of this ordinance, including treatability studies to determine whether the wastewater would be compatible with all sewerage facilities. This information shall include, but is not limited to the following:
1. Wastewater discharge flow rates, peak flow rates and volume over any period of time.
  2. Physical, chemical or bacteriological analysis of wastewater.
  3. Information on raw materials, processes and products.
  4. Quantity, disposition and waste manifests of specific liquids, sludge, oil, solvent or other materials.
  5. Details of any pretreatment equipment.
  6. Details of systems to prevent and control the loss of material through spills and slug discharges.
  7. Review of all types of water bills.

#### **6.08 CONFIDENTIAL INFORMATION**

All user information and data on file with IRWD shall be available to the public and governmental agencies without restriction, unless the user specifically requests and is able to demonstrate to the satisfaction of ~~the IRWD~~IRWD that the release of such information would divulge information, processes or methods which would be detrimental to the user's competitive position. The demonstration of the need for confidentiality made by the user must meet the burden necessary for withholding such information from the general public under applicable state and federal law. Any such claim must be made at the time of submittal of the information by marking "Confidential Business Information" on each page containing such information within the submittal. Information which is demonstrated to be confidential shall not be transmitted to any governmental agency without prior notification to the user. Information concerning wastewater quality and quantity shall not be recognized as confidential information and shall be available to the public without reservation.

#### **6.09 CLASS I – WASTEWATER DISCHARGE (WD) PERMIT**

No user requiring a Class I WD Permit shall discharge wastewater without obtaining a Class I WD Permit. A Class I user, as determined by ~~the IRWD~~IRWD, proposing to discharge directly or

indirectly into a sewerage facility shall obtain a WD Permit by filing an application and paying any applicable fees before discharging.

**6.10 CLASS II – WASTEWATER DISCHARGE (WD) PERMIT**

No user requiring a Class II WD Permit shall discharge wastewater without obtaining a Class II WD Permit. A Class II user, as determined by ~~the IRWD~~IRWD, proposing to discharge directly or indirectly into a sewerage facility shall obtain a WD Permit by filing an application and paying any applicable fees before discharging.

**6.11 CLASS III – WASTEWATER DISCHARGE (WD) PERMIT**

No user requiring a Class III WD Permit shall discharge wastewater without obtaining a Class III WD Permit. A Class III user, as determined by ~~the IRWD~~IRWD, proposing to discharge directly or indirectly into a sewerage facility shall obtain a WD Permit by filing an application and paying any applicable fees before discharging.

**6.12 CLASS IV – SPECIAL WASTEWATER DISCHARGE (SWD) PERMIT**

- A. No user requiring a Class IV SWD Permit shall discharge wastewater without obtaining a Class IV SWD Permit. A Class IV user, as determined by ~~the IRWD~~IRWD, proposing to discharge directly or indirectly into a sewerage facility shall obtain a SWD Permit by filing an application and paying any applicable fees before discharging.
- B. The SWD Permit may be issued when no alternative method of disposal is reasonably available or to mitigate an environmental risk or health hazard.
- C. A user proposing to discharge diverted urban nuisance water may be issued a nuisance special wastewater discharge (NSWD) Permit only after they have completed the requirements contained in ~~the IRWD~~IRWD and SOCWA “Nuisance Flow Diversion Policy.”
- D. A user proposing to discharge trucked or hauled wastes may be issued a hauled special wastewater discharge (HSWD) Permit only after they have completed all requirements set forth by ~~the IRWD~~IRWD on a case by case basis. All trucked or hauled waste users shall comply with the terms, conditions and limitation set forth in a HSWD Permit as determined by ~~the IRWD~~IRWD to be necessary to protect sewerage facilities. A trucked or hauled waste user proposing to discharge waste into a IRWD or SOCWA sewerage facility may be required to obtain both a valid Orange County Health Department permit (where applicable) and a HSWD Permit prior to any discharge.

**6.13 NON-INDUSTRIAL WASTEWATER DISCHARGE (NIWD) FORM**

- A. At the sole discretion of ~~the IRWD~~IRWD, any user that is considered to have wastewater of no concern discharging to sewerage facilities may be classified as an NIWD user and issued an NIWD form.
- B. Any user that has had a Class I, II, or III WD Permit that no longer has a discharge containing noncompatible wastes to ~~the IRWD~~IRWD's sewerage facilities may be classified as an NIWD user and issued an NIWD form.

- C. The main functions of the NIWD form are to assist in maintaining ~~the IRWD~~IRWD's user survey data base and to track and verify by inspection any user that is considered to have wastewater of no concern discharging to sewerage facilities.

**6.14 APPLICATION FOR WASTEWATER DISCHARGE PERMIT**

- A. Users required to obtain a WD Permit shall complete and file with ~~the IRWD~~IRWD, prior to commencing discharge, if applicable, an application on a form prescribed by ~~the IRWD~~IRWD.
- B. Users seeking a WD Permit may be required to submit, in unit and terms appropriate for evaluation, the following information:
  - 1. Name, address of the site, NAICS numbers (if applicable), and a description of the manufacturing process or service activity.
  - 2. Name, address of any and all, (whichever is applicable) principals/owners/major share holders of company; articles of incorporation; most recent report of the Secretary of State and business license.
  - 3. Flow, volume, time, duration and type of wastewater to be discharged.
  - 4. Name, address and contact information of the individual who shall serve as the CAR.
  - 5. Name and address of property owner, landlord and/or manager of the property.
  - 6. Water supplier and water account numbers. Wastewater constituents and characteristics as required or deemed necessary by ~~the IRWD~~IRWD, including but not limited to, those mentioned in this ordinance. These constituents and characteristics shall be determined by a laboratory of the discharger approved by ~~the IRWD~~IRWD.
  - 8. Number of employees and average hours of work per employee per day.
  - 9. Waste minimization, best management practices and water conservation practices.
  - 10. All production records, if applicable.
  - 11. Waste manifests, if applicable.
  - 12. Tons of cooling tower capacity, if applicable.
  - 13. List of other environmental control permits and EPA Hazardous Waste Generator number, if applicable.
  - 14. Application signed by CAR of the user and contains the certification statement in Section 802.E
  - 15. Any other information as specified.

- C. Users may be required to submit site floor, mechanical, plumbing, toxic organic management, and spill containment plans for evaluation.
- D. After evaluation of the data furnished, ~~the IRWD~~IRWD may issue a WD Permit, a NIWD Form or other control mechanism subject to the terms and conditions set forth in this ordinance and as otherwise determined by the General Manager to be necessary to protect sewerage facilities.
- E. The WD Permit application may be denied if the user fails to establish to IRWD's satisfaction that adequate pretreatment equipment is included within the user's plans to ensure that the discharge limits will be met or if the user has, in the past demonstrated an inability to comply with applicable discharge limits or has in the past demonstrated an inability to keep current with invoices for the items such as WD Permit fees, noncompliance fees, civil penalties, administrative civil penalties or charge for use.

#### **6.15 APPLICATION FOR SPECIAL WASTEWATER DISCHARGE PERMIT**

- A. Users required to obtain a SWD Permit shall complete and file with ~~the IRWD~~IRWD, prior to commencing discharge, if applicable, an application on a form prescribed by ~~the IRWD~~IRWD.
- B. Users seeking a SWD Permit may be required to submit, in unit and terms appropriate for evaluation, the following information:
  - 1. Name, address and a description of the wastewater to be discharged.
  - 2. Name, address and contact information of the individual who shall serve as the CAR.
  - 3. Volume, time and duration of wastewater to be discharged.
  - 4. Construction and plumbing plans, if applicable.
  - 5. Detailed analysis of the alternatives for wastewater disposal, if applicable.
  - 6. Wastewater constituents and characteristics as required or deemed necessary by ~~the IRWD~~IRWD, including but not limited to, those mentioned in this ordinance. These constituents and characteristics shall be determined by a laboratory selected by the user acceptable to ~~the IRWD~~IRWD.
  - 7. Any other data as specified.
- C. Users may be required to submit site, mechanical, plumbing, toxic organic management, and spill containment plans for evaluation if applicable.
- D. After evaluation of the information furnished, IRWD may issue a SWD Permit or other control mechanism subject to the terms and conditions set forth in this ordinance and as otherwise determined by the General Manager to be necessary to protect sewerage facilities.

- E. In the case of diverted urban nuisance water, after evaluation of the information furnished, IRWD may issue a NSW Permit, subject to the terms and conditions set forth in this ordinance and the “Nuisance Flow Diversion Policy” as otherwise determined by the General Manager to be necessary to protect sewerage facilities.
- F. The SWD Permit application may be denied if the user fails to establish to IRWD’s satisfaction that adequate pretreatment equipment is included within the user’s plans to ensure that the discharge limits will be met or if the user has, in the past demonstrated an inability to comply with applicable discharge limits or has in the past demonstrated an inability to keep current with invoices for items such as SWD Permit fees, non-compliance fees, civil penalties, administrative civil penalties or charges for use .

**6.16 APPLICATION FOR NON-INDUSTRIAL WASTEWATER DISCHARGE (NIWD) FORM**

- A. Users meeting the criteria for a NIWD form may be asked to complete and file with ~~the IRWD~~IRWD an application on a form prescribed by ~~the IRWD~~IRWD.
- B. Information on users that meet the criteria for a NIWD form may be obtained solely by ~~the IRWD~~IRWD during site inspections or by other means.
- C. After evaluation of the data furnished by the user or from information collected solely by ~~the IRWD~~IRWD an NIWD form may be issued.

**6.17 WASTEWATER DISCHARGE PERMIT TERMS, CONDITIONS, AND LIMITATIONS**

- A. All wastewater discharge permits shall be expressly subject to all terms, conditions, and limitations of this ordinance, other regulatory agencies, Best Management Practices, charge for use, and fees established by ~~the IRWD~~IRWD. The terms, conditions, and limitations in a WD Permits are subject to enforcement by ~~the IRWD~~IRWD in accordance with this ordinance, and applicable state and federal regulations. Any WD Permit violation shall be a violation of this ordinance.
- B. The terms, conditions, and limitations of any issued WD Permit may be subject to modification and changes by ~~the IRWD~~IRWD during the life of the WD Permit based on:
  - 1. The discharger’s current or anticipated operating data.
  - 2. ~~The IRWD~~IRWD’s current or anticipated operating data.
  - 3. Changes in the requirements of regulatory agencies.
- C. Users may request a modification to the terms, conditions, and limitations of an issued WD Permit. The request shall be in writing stating the requested change, and the reasons for the change. ~~The IRWD~~IRWD shall review the request, make a determination and respond in writing. A request for a wastewater discharge permit modification does not relieve a user from complying with its existing WD Permit terms, conditions and limitations.
- D. Any changes to the terms, conditions or limitations in a WD Permit shall include a reasonable time schedule for compliance where allowed under applicable federal, state and local law.



- E. A WD Permit may contain any, but is not limited to, the following terms, conditions and limitations:
1. Effluent limits, including mass emission rates, concentration limits or best management practices based on applicable pretreatment standards for regulated pollutants.
  2. Discharge limits based upon the combined wastestream formula (CWF).
  3. Limits on rate and time of discharge or requirements for flow regulation and equalization.
  4. Requirements for the user to make notification in writing prior to the physical expansion or any change to any wet processes. Notification is also required in the event of changes in production if production-based limits are being applied.
  5. Requirements for the user to construct and maintain, at the user's own expense, pH control, flow monitoring and/or sampling equipment and/or structures.
  6. Requirements for submission of technical reports, discharge reports and waste manifests.
  7. Location of sampling point(s) and the requirements to self-monitor. Requirements for maintaining plant records relating to wastewater discharge and waste manifests as specified by ~~the IRWD~~IRWD.
  9. Predetermined rates or values for wastewater strength characteristics.
  10. Requirements to submit copies of water bills.
  11. Other provisions which may be applicable to ensure compliance with this ordinance.
  12. Other terms, conditions and limitations determined by ~~the IRWD~~IRWD to be necessary to protect sewerage facilities.
  13. Predetermined rate or value for BOD and suspended solids.
  14. Requirements for notification of bypass discharges.
  15. Requirements for notification of any new introduction of wastewater constituents or any substantial change in the volume or character of wastewater constituents.
  16. Requirements to meet compliance schedules.
  17. Requirements for the user to control slug discharges by developing and implementing a slug discharge control plan if determined by ~~the IRWD~~IRWD to be necessary as described in 40 CFR 403.8(f)(1)(iii)(B)(6).
  18. Requirements for the user to control toxic organic discharges by developing and implementing a toxic organics management plan if determined by ~~the IRWD~~IRWD to be necessary.



**6.18 WASTEWATER DISCHARGE PERMIT DURATION**

All wastewater discharge permits shall not exceed a duration of five (5) years. Any wastewater discharge permit may be issued for a shorter period of time at the sole discretion of ~~the~~ IRWD/IRWD.

**6.19 WASTEWATER DISCHARGE PERMIT RENEWAL**

- A. The user may file a new application prior to the expiration date of any existing wastewater discharge permit for renewal.
- B. Discharge after the termination date of a wastewater discharge permit is prohibited except:
  - 1. If the user filed a timely renewal application which is complete, and:
  - 2. ~~The IRWD/IRWD~~, through no fault of the user, does not issue a new wastewater discharge permit with an effective date on or before the expiration date of the previous wastewater discharge permit.

**6.20 IRWD'S RIGHT OF REVISION**

- A. IRWD reserves the right to establish, by ordinance, or by wastewater discharge permit or by Best Management Practices, or by any other control mechanism, more stringent standards or requirements on ~~the discharge of users'~~ discharge to sewerage facilities
- B. The terms, conditions and limitations contained in any WD Permit, Best Management Practices or other control mechanism may be modified by IRWD at any time. This modification shall be by written notification to the user.

**ARTICLE 7  
PRETREATMENT EQUIPMENT REQUIREMENTS**

**7.01 PRETREATMENT**

- A. All pretreatment equipment or devices may be reviewed by ~~the IRWD/IRWD~~. Such review shall not absolve the user of any responsibility of meeting prohibitions, limitations, requirements, standards and local limits on discharges.
- B. User shall provide wastewater treatment as necessary which may include, but is not limited to, the use of best available technology (BAT) or best practicable technology (BPT) concepts to comply with this ordinance and shall achieve compliance with all prohibitions, limitations, standards and local limits before discharging to any sewerage facility. Any equipment required to pretreat, sample, control or transport wastewater shall be provided and maintained in proper operating condition at all times at the user's sole expense.
- C. User may be required to submit waste analysis plans, contingency plans, and meet other requirements to ensure proper operation of pretreatment equipment and compliance with their wastewater discharge permit limits and this ordinance.

- D. No user shall increase the use of water or in any other manner attempt to dilute a discharge as a partial or complete substitute for treatment to achieve compliance with this ordinance, a wastewater discharge permit or other control mechanism.

## 7.02 **SPILL CONTAINMENT**

- A. Each user shall provide spill containment for protection against the discharge of prohibited materials or other wastes regulated by this ordinance. This protection shall be designed in accordance with reasonable engineering standards to secure the discharges and to prevent them from entering into a sewerage facility. This equipment shall be provided and maintained at the user's sole expense.
- B. If it can be shown that a user's spill containment equipment did not prevent a discharge which caused ~~the IRWD~~IRWD to violate its requirements, incur additional operational expenses, or suffer loss or damage to sewerage facilities, that user shall be responsible for any costs or expenses, including assessment by other agencies or any costs incurred by ~~the IRWD~~IRWD.
- C. A notice may be permanently posted on the user's bulletin board or other prominent place advising employees who to call in the event of a prohibited discharge. Employers shall ensure that all employees who may cause or suffer such a prohibited discharge to occur are advised of the emergency notification procedure.

## 7.03 **MONITORING AND METERING EQUIPMENT**

- A. The user may be required to construct and maintain in proper operating condition at the user's sole expense, flow and/or constituent monitoring and/or sampling equipment.
- B. Any sample taken from a user's sample point shall be considered to be representative of the discharge to sewerage facilities.
- C. Monitoring or metering equipment may be required to include a security enclosure that can be locked with a IRWD provided lock during any sampling and monitoring periods.
- D. Location of the monitoring or metering equipment shall be subject to approval by ~~the IRWD~~IRWD.
- E. ~~The IRWD~~IRWD shall be provided clear and uninterrupted access to monitoring or metering locations.
- F. When one or more users discharge into a sewerage facility, those users may be required to install a separate monitoring location for each user. Also in the judgment of ~~the IRWD~~IRWD, if there is a significant difference in wastewater constituents and characteristics produced by different operations of a single user, that user may be required to install separate monitoring locations for each operation. Separate monitoring may also be required for different processes subject to categorical pretreatment standards.
- G. Users with the potential to discharge flammable solutions may be required to install and maintain at their sole expense a combustible gas detection meter.

- H. All wastewater samples shall be representative of the user's discharge. Wastewater monitoring and flow measurement equipment shall be operated, kept clean, and maintained in good working order at all times. Failure by the user to keep its monitoring equipment in good working order shall not be grounds for the user to claim that sample results are unrepresentative of its discharge.

**7.04 DRAWING SUBMITTALS**

- A. Detailed plans of any proposed construction of pretreatment, spill containment, monitoring and metering equipment and operating procedures shall be submitted for review by the due date contained within a written request from ~~the IRWD~~IRWD. The review of the plans and procedures shall in no way relieve the user of the responsibility of modifying the equipment or procedures in the future as necessary to meet the requirements of this ordinance or any other requirement of other regulatory agencies.
- B. All drawings shall include:
  - 1. North arrow.
  - 2. Scale size.
  - 3. User name and address.
  - 4. Date drawn or revised.
  - 5. Location of proposed pretreatment, spill containment, monitoring and metering equipment.
- C. ~~The IRWD~~IRWD may require drawings to scale depicting the manufacturing process (waste generating source), spill containment, pretreatment and/or monitoring or metering equipment.
- D. ~~The IRWD~~IRWD may require a schematic drawing of the pretreatment, spill containment, monitoring and metering equipment.
- E. ~~The IRWD~~IRWD may require the drawings be prepared by a California registered chemical, mechanical, or civil engineer.

**7.05 WASTE MINIMIZATION, RECYCLING, AND TREATMENT**

- A. User shall provide waste minimization plans to conserve water, investigate product and/or materials substitution, maintain inventory control records and implement employee education, and other steps as necessary to minimize waste produced by the due date contained within a written request from ~~the IRWD~~IRWD.
- B. Waste minimization, recycling and treatment shall be demonstrated wherever feasible in the following priority:
  - 1. Source reduction which includes, but is not limited to, substitution of less hazardous materials, spill prevention and control measures, proper storage and handling of chemicals and raw materials.

2. Recovery and reuse which includes, but is not limited to, substitution of less hazardous materials, spill prevention and control measures, proper storage and handling of chemicals and raw materials.
3. Treatment which includes, but is not limited to, pretreatment techniques as to render hazardous wastes harmless or suitable for disposal to sewerage facilities.

**ARTICLE 8  
INSPECTION, MONITORING, SAMPLING,  
NOTIFICATION, AND REPORTING REQUIREMENTS**

**8.01 INSPECTION AND MONITORING**

- A. ~~The IRWD~~IRWD may inspect and sample the wastewater generating and disposal equipment of any user's site to ascertain whether the requirements of this ordinance are being met and the user is complying with all requirements.
- B. Where a user has instituted security measures requiring proper identification and clearance before entry onto the premises, the user shall make all necessary arrangements with its security in order that the inspectors of ~~the IRWD~~IRWD shall be allowed to enter the premises without delay for the purpose of performing their authorized duties.
- C. ~~The IRWD~~IRWD shall have the right to set up on the user's property or any other locations, as determined by ~~the IRWD~~IRWD, such devices as are necessary to conduct sampling or metering operations of the user's discharge to sewerage facilities.
- D. In order for ~~the IRWD~~IRWD to determine the wastewater characteristics of a discharge for compliance with this ordinance, wastewater discharge permit, or other control mechanism requirements, the user may be required to make available for inspection and copying all records including, but not limited to, production records, required self-monitoring and chain of custody records, any additional records of information obtained pursuant to monitoring activities undertaken by the user independent of such requirements, documents associated with Best Management Practices and waste manifests without restriction, but subject to the confidential provisions set forth in this ordinance. All records shall be maintained by users for a minimum of three (3) years. This period shall be automatically extended for the duration of any litigation concerning the user, or when the user has been notified by written request from ~~the IRWD~~IRWD. Such records shall be made available to ~~the IRWD~~IRWD upon request.
- E. Any temporary or permanent obstruction to safe and easy access to the user's site to be inspected and/or sampled shall be promptly removed by the user at the written or verbal request of ~~the IRWD~~IRWD and shall not be replaced. The costs of cleaning such access shall be at the sole expense of the user.
- F. Inspection and/or sampling of any user's site shall be conducted at any time, by any means, in any amount, at any location, on any limit, requirement or pollutant in a manner and frequency as determined at the sole discretion of ~~the IRWD~~IRWD.

## 8.02 SELF-MONITORING AND REPORTING

- A. Self-monitoring of wastewater pollutants, constituents and characteristics of the user needed for determining compliance with any limitations and requirements as specified in the user's wastewater discharge permit, federal regulations, or this ordinance may be required. The self-monitoring requirement, frequency, forms and reporting shall be set forth in the user's wastewater discharge permit or other control mechanism. These reports may include, but are not limited to, the following:
1. Baseline monitoring reports (BMR's).
  2. Compliance schedule progress reports.
  3. 90-day compliance reports.
  4. Self-monitoring reports containing monitoring and analysis to demonstrate continued compliance as described in 40 CFR 403.12(g)(1-6).
  5. Other reports as required by ~~the IRWD~~IRWD, other regulatory agencies or applicable law.
- B. Failure by the user to perform any self-monitoring or reporting required by ~~the IRWD~~IRWD ~~shall be~~is a violation of this ordinance, and is ~~deemed to be~~ a violation for each parameter and each day in the time period for which monitoring was required, and is cause for ~~the IRWD~~IRWD to initiate all necessary tasks and analysis to the wastewater pollutants, constituents and characteristics for any limitations and requirements specified in the user's wastewater discharge permit or in this ordinance. The user shall be responsible for any and all expenses incurred by ~~the IRWD~~IRWD in undertaking such monitoring analysis and preparation of reports. All users required to sample and analyze their wastewater shall use the sampling methods and the sampling locations as set forth in their wastewater discharge permit. For each sample collected and analyzed, the user shall maintain a record of:
1. Date, exact place, method and time of sampling and the name of the person taking the sample.
  2. Date analysis performed.
  3. Identity and address of the person who performed the analysis.
  4. The analytical methods used.
  5. Results of the analysis.
- D. Samples taken shall be representative of conditions occurring during the reporting period. Users shall submit all monitoring data, even if user samples more frequently than required by its wastewater discharge permit. User is required to provide advance notice of any substantial change in the volume or character of pollutants in their discharge.

- E. When required, all submitted applications and user reports shall be signed by the CAR as defined in this ordinance. Each application and any required user report shall contain the following certification:

"I certify under penalty of law that this document and all attachments were prepared under my direction or supervision in accordance with a system designed to assure that qualified personnel properly gather and evaluate the information submitted. Based on my inquiry of the person or persons who manage the system, or those persons directly responsible for gathering the information, the information submitted is, to the best of my knowledge and belief, true, accurate, and complete. I am aware that there are significant penalties for submitting false information, including the possibility of fine and imprisonment for knowing violations."

Date: \_\_\_\_\_

Signature: \_\_\_\_\_

Print Name: \_\_\_\_\_

Title: \_\_\_\_\_

User Name: \_\_\_\_\_

User Site Address: \_\_\_\_\_

User Mailing Address: \_\_\_\_\_

Phone: \_\_\_\_\_

Permit No: \_\_\_\_\_

- F. Self-monitoring reports shall be subject to the provisions of 18 U.S.C. Section 1001 relating to false statements and fraud and the provisions of Section 309(c)(2) of the Act governing false statements.
- G. The analysis of a user's wastewater pollutants, constituents and characteristics shall be done by a laboratory approved by ~~the IRWD~~IRWD.
- H. If self-monitoring indicates a violation, the user shall notify ~~the IRWD~~IRWD within 24 hours of becoming aware of the violation. The user shall repeat the sampling and analysis and submit the results of the repeat analysis to ~~the IRWD~~IRWD within 30 days after ~~event becoming aware of the violation~~the repeat sampling event. Resampling by a user is not required if ~~the IRWD~~IRWD performs the sampling at the user's site at least once a month, or if ~~the IRWD~~IRWD performs sampling at the user between the time when the initial sampling was conducted and the time when the user or the user or the IRMNWD receives the results of the sampling, or if ~~the IRWD~~IRWD has ~~performed~~performed the sampling and analysis in lieu of the user. The analysis of wastewater pollutants, constituents and characteristics and the preparation of the self-monitoring report shall be done at the sole expense of the user.

- J. The user shall establish and maintain a sample point on each discharge line at a location representative of the discharge to sewerage facilities. The maintenance of any sample point equipment shall be done at the sole expense of the user. Any sampling location shall be set forth in the user's wastewater discharge permit.
- K. Any user subject to the reporting requirements of this ordinance shall retain all records of monitoring activities and results for a minimum of three (3) years and shall make them available to ~~the IRWD~~IRWD upon request. ~~The IRWD~~IRWD may require a longer period of retention if litigation is being considered or has resulted.
- L. Any user subject to self-monitoring reporting requirements may be required to submit self-monitoring reports on forms approved by ~~the IRWD~~IRWD.
- M. Any user determined to be a non-significant categorical industrial user (NSCIU) by SOCWA pursuant to Section 202.B.86.c. and 808.B shall annual submit the following certification statement signed by the CAR as defined in this ordinance. This certification shall accompany an alternative report required by SOCWA:

"Based on my inquiry of the person or persons directly responsible for managing compliance with categorical pretreatment standards under 40 CFR \_\_\_\_, I certify that, to the best of my knowledge and belief that during the period from January 1, \_\_\_\_ to December 31, \_\_\_\_:

(a) The facility described as \_\_\_\_\_ met the definition of non-significant categorical industrial user as described in Section 202.B.86.c.;

(b) The facility complied with all applicable pretreatment standards and requirements during this reporting period; and (c) the facility never discharged more then 100 gallons of total categorical wastewater on any given day during this reporting period.

Date: \_\_\_\_\_

Signature: \_\_\_\_\_

Print Name: \_\_\_\_\_

This compliance certification is based on the following information.  
\_\_\_\_\_

### **8.03 REPORT OF SPILL, SLUG DISCHARGE, BATCH DUMPING OR UPSET**

- A. In the event the user is unable to comply with any of the wastewater discharge permit conditions due to a breakdown of equipment, accidents caused by human error, or intentional action by any party, or acts of God, or any other cause, the discharger shall notify ~~the IRWD~~ as soon as possible of any spill, slug discharge, batch dumping or upset.
- B. Confirmation of this notification shall be made in writing within five (5) working days of the original notification unless waived by ~~the IRWD~~IRWD. The written notification shall contain:



1. Date of the incident.
  2. Reason for the spill, slug discharge, batch dumping or upset.
  3. The steps that were taken to immediately correct the problem.
  4. The steps that are being taken to prevent the problem from recurring.
  5. Any other information ~~the IRWD~~IRWD deems relevant.
- C. Such notification shall not relieve the user of any expense, loss, damage, liability or fees which may be incurred as a result of damage or loss to sewerage facilities or any damage or loss to persons or property. Such notification shall never relieve the user from any fees or liability which may be imposed by this ordinance, other regulatory agencies or other applicable law.
- D. Significant industrial users shall notify IRWD immediately of any changes at its site affecting the potential for a slug discharge

#### **8.04 REPORTING OF BY-PASS**

- A. By-pass of industrial wastewater through pretreatment equipment to the sewerage facilities is prohibited. Enforcement action may be taken against the user, unless:
1. By-pass was unavoidable to prevent loss of life, personal injury, or severe property damage, and
  2. There were no feasible alternatives to the by-pass, such as the use of auxiliary treatment equipment, retention of untreated wastes, or maintenance during normal periods of equipment downtime. This condition is not satisfied if adequate back-up equipment should have been installed in the exercise of reasonable engineering judgment to prevent a by-pass which occurred during normal periods of equipment downtime or preventative maintenance, and
  3. The user submitted notice as required by this ordinance, or;
  4. The bypass did not exceed user discharge limits and was required for essential maintenance.
- B. If a user knows in advance of the need for a by-pass, it shall submit prior notice to ~~the IRWD~~IRWD at least ten (10) days before the date of the by-pass.
- C. ~~The IRWD~~IRWD may approve an anticipated by-pass after considering its adverse effects, if ~~the IRWD~~IRWD determines that it will meet the conditions listed within this section. A user shall submit notice of an unanticipated by-pass that exceeds their wastewater discharge permit limitation to ~~the IRWD~~IRWD within 24 hours from the time the user becomes aware of the by-pass. A written report shall also be provided within five (5) working days of the time the user becomes aware of the by-pass. The report shall contain:
1. Description of the by-pass and its cause.



2. Duration of the by-pass, including exact dates and times.
  3. Anticipated time it is expected to continue if the by-pass has not been corrected.
  4. Steps taken or planned to reduce, eliminate, and prevent recurrence of the by-pass.
- E. Failure to submit notice and/or written report may be grounds for wastewater discharge permit suspension or revocation. Failure to provide timely notice under Section 804 D. is deemed a waiver of the bypass defense for the user violation.
- F. Such notification shall not relieve the user of any expense, loss, damage, or other liability which may be incurred as a result of damage or loss to sewerage facilities or any other damage or loss to person or property. Such notification shall never relieve the user from any fees or liability that may be imposed by this ordinance, other regulatory agencies or other applicable law.

#### **8.05 BASELINE MONITORING REPORTS (40 CFR 403.12(B))**

- A. Within either one hundred eighty (180) days after the effective date of a categorical standard or the final administrative decision on a category determination under 40 CFR 403.6(a)(4), whichever is later, an existing categorical industrial user currently discharging to or scheduled to discharge shall submit to ~~the IRWD~~IRWD a report containing the information listed below. At least ninety (90) days prior to commencement of discharge, new sources, and sources that become categorical industrial users subsequent to the promulgation of an applicable categorical standard shall submit to ~~the IRWD~~IRWD a report containing the information listed below. A new source shall report the method of pretreatment it intends to use to meet applicable categorical standards. A new source also shall give estimates of its anticipated flow and quantity of pollutants to be discharged. The baseline monitoring report shall include, but is not limited to, the following:
1. Identifying information. The name and address of the site, including the name of the operator and owner.
  2. Permits. A list of any environmental control permits held by or for the site. Description of Operations. A brief description of the nature, average rate of production, and North America Industrial Classification of the operation(s) carried out by such industrial user. This description should include a schematic process diagram which indicates points of discharge to sewerage facilities from the regulated processes.
  4. Flow Measurements. Information showing the measured average daily and maximum daily flow, gpd, to sewerage facilities from regulated process streams and other streams as necessary.
  5. Measurement of Pollutants. The categorical pretreatment standards applicable to each regulated process and the results and analysis identifying the nature and concentration, and/or mass, where required by the standard or by ~~the IRWD~~IRWD, of regulated pollutants in the discharge from each regulated process. Instantaneous, daily maximum, and long-term average concentrations,

or mass where required, shall be reported. The sample shall be representative of daily operations. In cases where the standards requires compliance with a BMP or pollution prevention alternative, the industrial user shall submit documentation as required by ~~the IRWD~~IRWD or the applicable standards to determine compliance with the standard.

6. Certification. A statement, reviewed by the user's CAR and certified by a qualified professional, indicating whether pretreatment standards are being met on a consistent basis, and if not, whether additional operation and maintenance (O&M) and/or additional pretreatment is required to meet the pretreatment standards and requirements.
7. Compliance schedule. If additional pretreatment and/or O&M will be required to meet the pretreatment standards, the shortest schedule by which the industrial user will provide such additional pretreatment and/or O&M. The completion date in this schedule shall not be later than the compliance date established for the applicable pretreatment standard.
8. Signature and certification. All monitoring reports shall be signed and certified in accordance with Section 802 E. of this ordinance.

**8.06 REPORT ON PROGRESS IN MEETING COMPLIANCE SCHEDULES(40 CFR 403.12(C))**

- A. All Class I users required to submit compliance schedules shall report their progress no later than fourteen (14) days after each due date contained in their compliance schedule.
- B. The schedule shall contain increments of progress in the form of dates for the commencement and completion of major events leading to the construction and operation of additional pretreatment required for the user to comply with the applicable pretreatment standards.
- C. No increment referred to above shall exceed nine (9) months.
- D. In no event shall more than nine (9) months elapse between progress reports to ~~the~~IRWD.

**8.07 REPORT ON COMPLIANCE WITH CATEGORICAL PRETREATMENT STANDARDS DEADLINE (40 CFR 403.12(D))**

- A. Within ninety (90) days following the date for final compliance with the applicable categorical standards or within ninety (90) days of the introduction of wastewater into sewerage facilities, the affected user shall submit a report containing the information listed below. This report shall include, but is not limited to the following:
  1. Flow Measurements. Information showing the measured average daily and maximum daily flow, in gallons per day, to sewerage facilities from regulated process streams and other streams.
  2. Measurement of Pollutants. The categorical pretreatment standards applicable to each regulated process and the results and analysis identifying the nature and concentration, and/or mass, where required by the standard or by ~~the~~

~~IRWD~~IRWD, of regulated pollutants in the discharge from each regulated process. Instantaneous, daily maximum, and long-term average concentrations, or mass where required, shall be reported. The sample shall be representative of daily operations.

~~3.4.~~ Certification. A statement, reviewed by the user's CAR and certified by a qualified professional, indicating whether pretreatment standards are being met on a consistent basis, and if not, whether additional operation and maintenance (O&M) and/or additional pretreatment is required to meet the pretreatment standards and requirements.

~~4.5.~~ Signature and certification. All monitoring reports shall be signed and certified in accordance with Section 802 E. of this ordinance.

### **8.08 PERIODIC COMPLIANCE REPORT**

- A. All Class I users subject to federal pretreatment standards (except a non-significant categorical user) as a minimum shall submit reports containing the information required in 40 CFR 403.12 during the months of June and December, or as required in their wastewater discharge permit or other control mechanism.
- B. A Class I user determined to be a non-significant categorical industrial user by ~~the~~ IRWDIRWD pursuant to Section 2.02.B.86.c. shall annually submit a report containing information as required in their wastewater discharge permit or other control mechanism.
- C. All users may be required to submit periodic compliance reports containing information as required in their wastewater discharge permit, other control mechanism or as required by ~~the~~ IRWDIRWD.

### **8.09 RIGHT OF ENTRY**

IRWD shall have the right to enter the premises of any user to determine whether the user is complying with the requirements of this ordinance and any individual wastewater discharge permit, other control mechanism or order issued hereunder. Users shall allow ~~the~~ IRWDIRWD ready access to all parts of the premises for the purpose of inspection, sampling, records examination and copying, and the performance of any other duties.

### **8.10 ANALYTICAL REQUIREMENTS**

- A. All pollutant analyses, including sampling techniques, to be submitted as part of a wastewater discharge permit application or report shall be performed in accordance with the techniques prescribed in 40 CFR
- B. Part 136 and amendments thereto, unless otherwise specified in an applicable categorical pretreatment standard. If 40 CFR Part 136 does not contain sampling or analytical techniques for the pollutant in question, or where the EPA determines that the Part 136 sampling and analytical techniques are inappropriate for the pollutant in question, sampling and analyses shall be performed by using validated analytical methods or any other applicable sampling and analytical procedures, including procedures suggested by ~~the~~ IRWDIRWD or other parties approved by the EPA.

### **8.11 SAMPLE COLLECTION**

- A. Samples collected by the user to satisfy reporting requirements contained in this ordinance, their wastewater discharge permit or other control mechanism shall be based on data obtained through appropriate sampling and analysis performed during the period covered by the report, based on data that is representative of conditions occurring during the reporting period.
- B. Except as indicated in Section 8.11.C. and 8.11.D. below, the user shall collect wastewater samples using 24-hour flow-proportional composite sampling techniques, unless time-proportional composite sampling or grab sampling is authorized by ~~the IRWD~~IRWD. Where time-proportional composite sampling or grab sampling is authorized by ~~the IRWD~~IRWD, the samples shall be representative of the discharge. Using protocols specified in 40 CFR 136 and appropriate EPA guidance, multiple grab samples collected during a 24-hour period may be composited prior to the analysis as follows: for cyanide, total phenols and sulfides the samples may be composited in the laboratory or in the field; for volatile organics and oil and grease, the samples may be composited in the laboratory. Composite samples for other parameters unaffected by the compositing procedures as documented in approved EPA methodologies may be authorized by ~~the IRWD~~IRWD, as appropriate. In addition, grab samples may be required at any time to show compliance with instantaneous discharge limits.
- C. Samples for analysis of oil and grease, temperature, pH, cyanide, total phenols, sulfides, and volatile organic compounds shall be obtained using grab sample collection techniques.
- D. For sampling required in support of baseline monitoring and 90-day compliance reports required by this ordinance and 40 CFR 403.12(b) and (d), a minimum of four (4) grab samples shall be used for pH, cyanide, total phenols, oil and grease, sulfide and volatile organic compounds for users for which historical sampling data do not exist; for users for which historical sampling data are available, IRWD may authorize a lower minimum. For reports required by this ordinance and 40 CFR 403.12(e) and (h), the user shall collect the number of grab samples necessary to assess and assure compliance with applicable pretreatment standards and requirements.

### **8.12 TIMING**

Reports shall be deemed to have been submitted on the date postmarked. For reports that are not mailed or delivered with postage prepaid the date of receipt of the report shall govern.

### **8.13 NOTIFICATION OF CHANGED DISCHARGE**

All users that have been issued a wastewater discharge permit shall notify ~~the IRWD~~IRWD in advance of any substantial change in the volume or character of pollutants in their discharge in accordance with 40 CFR 403.12(j)

### **8.14 NOTIFICATION OF THE DISCHARGE OF HAZADOUS WASTE (40 CFR 403.12(P)(1))**

- A. The industrial user shall notify ~~the IRWD~~IRWD, the EPA Regional Waste Management Division Director, and State hazardous waste authorities in writing of any discharge into sewerage facilities of a substance, which, if otherwise disposed of, would be a

hazardous waste under 40 CFR part 261. Such notification must include the name of the hazardous waste as set forth in 40 CFR Part 261, the EPA hazardous waste number, and the type of discharge (continuous, batch, or other). If the industrial user discharges more than one hundred (100) kilograms of such waste per calendar month to sewerage facilities, the notification shall also contain the following information to the extent such information is known and readily available to the industrial user: An identification of the hazardous constituents contained in the wastes, an estimation of the mass and concentration of such constituents in the wastestream discharged during that calendar month, and an estimation of the mass of constituents in the wastestream expected to be discharged during the following twelve (12) months. All notifications must take place no later than one hundred and eighty (180) days after a discharge to sewerage facilities commences. Any notification under this section need be submitted only once for each hazardous waste discharged. However, notifications of changed discharges must be submitted under Section 813 of this ordinance and as listed in 40 CFR 403.12(j). The notification requirement in this section does not apply to pollutants already reported under the self-monitoring requirements of Sections 8.05, 8.07 and 8.08 of this ordinance and as listed in 40 CFR 403.12(b), (d), and (e).

- B. Dischargers are exempt from the requirements of Section 814. A., above, during a calendar month in which they discharge no more than fifteen (15) kilograms of hazardous wastes, unless the wastes are acute hazardous wastes as specified in 40 CFR 261.30(d) and 261.33(e). Discharge of more than fifteen (15) kilograms of non-acute hazardous wastes in a calendar month, or of any quantity of acute hazardous wastes as specified in 40 CFR 261.30(d) and 261.33(e), requires a one-time notification. Subsequent months during which the industrial user discharges more than such quantities of any hazardous waste do not require additional notification.
- C. In the case of any new regulations under Section 3001 of RCRA identifying additional characteristics of hazardous waste or listing any additional substance as a hazardous waste, the industrial user must notify ~~the IRWD~~IRWD, the EPA Regional Waste Management Waste Division Director, and State hazardous waste authorities of the discharge of such substance within ninety (90) days of the effective date of such regulations.
- D. In the case of any notification made under this section, the industrial user shall certify that it has a program in place to reduce the volume and toxicity of hazardous wastes generated to the degree it has determined to be economically practical.
- E. This section does not create a right to discharge any substance not otherwise permitted to be discharged by this ordinance, a permit issued thereunder, or any applicable Federal or State law.

## ARTICLE 9 ENFORCEMENT

### 9.01 ENFORCEMENT SCOPE

- A. ~~The~~IRWD finds that in order for it to comply with the laws, regulations, and rules imposed upon it by regulatory agencies and to ensure that sewerage facilities and

treatment processes are protected and are able to operate with the highest efficiency, specific enforcement provisions must be adopted to regulate discharges from industrial users.

- B. ~~The~~ IRWD is willing to cooperate with all users on improvements in wastewater quality, yet must be in a position to ensure that uncooperative users shall comply with this ordinance and any conditions set forth in a wastewater discharge permit.
- C. ~~The~~ IRWD intends to ensure that all interested parties are afforded due process of law and that any noncompliance or violation is resolved as soon as possible. Enforcement shall be guided by the IRWD Enforcement Response Plan (ERP), adopted by CSJC/SOCWA as Resolution No. 2009-02, which is adopted here by reference.
- ~~C.D.~~ All users have a right of appeal pursuant to the procedures set forth in this ordinance.
- ~~D.E.~~ Each non-compliance or violation per day and each day of noncompliance or violation shall be taken as a separate noncompliance or violation for determining the amount of fees, charges, fines or penalties and/or which enforcement actions may be taken. A violation of a weekly average is considered seven (7) days of violation for that parameter and a violation of a monthly average is based upon the number of days in that month. A violation of multiple parameters caused by a single operational upset is considered one violation.
- ~~E.F.~~ ~~\_\_\_\_\_ F. \_\_\_\_\_~~ The issuance or exercise of any type of an enforcement action provided for under this ordinance shall not be a bar against, or a prerequisite for, taking any other or additional enforcement action against a user under this ordinance or any other local, state or federal law. The remedies provided for in this ordinance are not exclusive and ~~the IRWD~~ IRWD is empowered to take more ~~then than~~ one enforcement action against any noncompliant user.

## 9.02 NOTICE OF NONCOMPLIANCE (NON)

- A. In the event that it is determined that a user is in noncompliance with any provision of this ordinance, or the terms, conditions and limitations of its wastewater discharge permit, ~~the IRWD~~ IRWD may issue a Notice of Noncompliance (NON) form, whereby the user shall comply with all directives, conditions and requirements therein within the time prescribed.
- B. The ~~issuance of a NON form~~ may contain terms and conditions including, but not limited to, installation of pretreatment equipment, sampling structures, submittal of drawings or technical reports, payment of fees or administrative fines, limits on rate and time of discharge or any other provisions to ensure compliance with this ordinance and the user's wastewater discharge permit. This action is not a prerequisite to taking other or more severe enforcement actions.

## 9.03 NOTICE OF VIOLATION (NOV)

- A. In the event that it is determined that a user has not responded to a NON ~~form~~ that was previously issued to them or that noncompliance of any pretreatment standards requires their immediate attention, ~~the~~ IRWD may issue a Notice of Violation (NOV) form,



~~identifying the violations and requiring whereby~~ the user ~~shall~~to comply with all directives, conditions and requirements therein within the time prescribed.

- B. The ~~issuance of a~~ NOV ~~form~~ may contain terms and conditions including, but not limited to, installation of pretreatment equipment and facilities, submittal of drawings or technical reports, payment of fees, administrative fines, limits on rate and time of discharge or any other provisions to ensure compliance with this ordinance. This action is not a prerequisite to taking other or more severe enforcement actions.

#### **9.04 9.04 ADMINISTRATIVE ORDER (AO)**

- A. The AO is an enforcement document from ~~the~~ IRWD directing the noncompliant user to undertake or to cease specific activities required to bring the user into compliance with this ordinance or the terms, conditions and limitation of a wastewater discharge permit as determined by ~~the~~ IRWD. The terms and conditions of the AO are not negotiable by the user. The circumstances of a user's noncompliance may dictate which theme the administrative order takes to achieve the earliest possible return to compliance by the user. AOs may include administrative complaints. Types of AOs may include, but are not limited to, the following:
1. Probation Order (PO)
    - a. The PO directs the noncompliant user to achieve compliance by a date specified in the order. The PO is usually issued when a user is in non-compliance of this ordinance, or the terms, conditions and limitations of its wastewater discharge permit or other enforcement action, or has not made payment of all amounts owed to ~~the~~ IRWD which include, but are not limited to, any fees, charges, fines and/or penalties. This action is not a prerequisite to taking other or more severe enforcement actions.
  2. Show Cause Order (SCO)
    - a. The SCO directs the noncompliant user to appear at a formal meeting, usually at a IRWD location, to explain its noncompliance, and to show cause why more severe enforcement actions against the user should not go forward. This action is not a prerequisite to taking other or more severe enforcement actions.
  3. Cease and Desist Order (CDO)
    - a. The CDO directs the noncompliant user to cease illegal or unauthorized discharges immediately, or to terminate its discharge altogether. A CDO may be issued in situations where a particular discharge could cause interference or pass through, or threaten human safety or the environment. The CDO may be issued immediately upon discovery of the problem. In an emergency, a CDO may be issued by any means, however, such an order should be followed by a written CDO on the user,. If necessary, ~~the IRWD~~IRWD may order immediate cessation of any discharge to the a sewerage facility, regardless of the user's compliance status. If a user fails to comply with the CDO, ~~the IRWD~~IRWD

may take any independent action to halt the discharge. This action is not a prerequisite to taking other or more severe enforcement actions.

## 9.05 WASTEWATER DISCHARGE PERMIT SUSPENSION OR REVOCATION

### A. Grounds

1. ~~The IRWD~~IRWD may suspend or revoke any wastewater discharge permit, ~~but is not limited to the following,~~ when it is determined that a user:
  - a. Violated an administrative order.
  - b. Provided a false statement, representation, record, report or other document to ~~the IRWD~~IRWD.
  - c. Refused to provide records, reports, plans or other documents required to determine wastewater discharge permit terms, conditions, or limitations, discharge compliance, or compliance with this ordinance.
  - d. Discharged effluent that causes pass-through or interference with sewerage facilities.
  - e. Falsified, tampered with, or knowingly rendered inaccurate any monitoring device or sample collection method.
  - f. Discharged effluent that endangers human health or the environment.
  - g. Failed to report significant changes in operations or wastewater constituents and characteristics.
  - h. Failed to comply with the terms and conditions of any enforcement action.
  - i. Refused reasonable access to the permittee's premises for the purpose of inspection and monitoring.
  - j. Failed to make timely payment of any fees, charges, fines or penalties owed to ~~the IRWD~~IRWD.
  - k. Violated any conditions or limitations of its wastewater discharge permit or any provision of this ordinance.
  - l. Discharged batch dumps to sewerage facilities not authorized or permitted by ~~the IRWD~~IRWD.

### B. Notice of Wastewater Discharge Permit Suspension/Revocation

1. When ~~the IRWD~~IRWD has reason to believe that grounds exist for suspension ~~or~~ revocation of a wastewater discharge permit, written notice shall be given by certified mail to the user setting forth a statement of facts and grounds deemed to exist together with a description of the time and place where the charge shall be heard by the General Manager. The hearing date shall not be less than fifteen (15) days nor more than sixty (60) days after the mailing of such notice.



C. Hearing on Permit Suspension/Revocation

1. At the wastewater discharge permit suspension/revocation hearing, the user shall have an opportunity to respond to the allegations set forth in the notice. The hearing shall be conducted in accordance with procedures established by the General Manager and approved by ~~the IRWD~~IRWD's General Counsel.
2. After the hearing, the General Manager's designee shall submit a written report to the General Manager setting forth a brief statement of facts found to be true, a determination of the issues presented, conclusions, and a recommendation.
3. Upon receipt of the written report, the General Manager shall make his determination. Should he find that the grounds exist for suspension ~~or~~ revocation of the wastewater discharge permit, he shall issue his decision and order, in writing within thirty (30) days after the hearing by his designee. A copy of the written decision shall be sent by personal delivery or certified mail to the user.

D. Effect of Wastewater Discharge Permit Suspension

1. Upon the issuance of an order of suspension by the General Manager, the user shall have no right to discharge any industrial wastewater, directly or indirectly to sewerage facilities for the duration of the suspension. All costs for physically terminating and reinstating service shall be paid by the user.
2. An order of wastewater discharge permit suspension issued by the General Manager shall be deemed final upon delivery to the user, unless appealed to the Board as specified in Section 913 of this ordinance.

E. Effect of Wastewater Discharge Permit Revocation

1. On the effective date of a wastewater discharge permit revocation being final, the user shall permanently lose all rights to discharge any industrial wastewater directly or indirectly to sewerage facilities. All costs for physical termination shall be paid by the user.
2. Each owner and employee of the user shall be bound by the order of wastewater discharge permit revocation. Any future application from any user subject to an order of wastewater discharge permit revocation will only be considered by ~~the IRWD~~IRWD after fully reviewing the records of revocation. Such records may be the basis for denial of a new wastewater discharge permit.
4. An order of permit revocation issued by the General Manager shall be deemed final upon delivery to the user, unless appealed to the Board as specified in Section 913 of this ordinance.

**9.06 TERMINATION OF SERVICE**

~~The~~ IRWD may physically terminate water or sewer service to any user that violates or continues to violate the provisions of this ordinance, a term of any order of suspension or revocation of a wastewater discharge permit or other control mechanism. All costs for physical termination shall be paid for by the user as well as all costs for reinstating services.

### 9.07 **EMERGENCY SUSPENSION**

- A. ~~The~~ IRWD's General Manager may suspend water or sewer service when such suspension is necessary, in order to stop an actual or impending discharge which presents or may present an imminent or substantial endangerment to the health and welfare of persons, to the environment, cause interference to sewerage facilities, or cause ~~the~~ IRWD to violate any state or federal law or regulation.
- B. An emergency suspension order is final and has no right of appeal.

### 9.08 **INJUNCTION**

Whenever a discharge of wastewater is in violation of the provisions of this ordinance, ~~the~~ IRWD may petition the superior court for the issuance of a preliminary or permanent injunction, or both, as may be appropriate to restrain the continuance of such discharge.

### 9.09 **CIVIL FINES AND PENALTIES**

- A. Authority.
  - 1. All users of sewerage facilities are subject to administrative or judicial enforcement actions by ~~the~~ IRWD, EPA, State Regional Water Quality Control Board or the District Attorney of Orange County. Actions may be taken pursuant to the authority and provisions of several laws, including but not limited to:
    - a. Federal Water Pollution Control Act (Clean Water Act).
    - b. California Porter-Cologne Water Quality Act (California Water Code).
    - c. California Hazardous Waste Control Law.
    - d. Resource Conservation and Recovery Act (RCRA).
- B. Recovery of Fines or Penalties.
  - 1. Payment of fines or penalties by ~~the IRWD~~ IRWD due to enforcement actions of other regulatory agencies based upon a violation by ~~the IRWD~~ IRWD whose cause can be established as the discharge of any user which is in violation of any provisions of this ordinance or a wastewater discharge permit shall entitle ~~the IRWD~~ IRWD to recover from the user all cost and expenses, including, but not limited to the full amount of fines and penalties which ~~the IRWD~~ IRWD has been subjected to.
  - 2. Each violation shall constitute a new and separate violation and shall be subject to the fines and penalties contained herein.
- C. Civil Liability
  - 1. Pursuant to the authority of California Government Code Sections 54739-54740, any user, permittee, discharger or other person who violates any provision of this ordinance, any wastewater discharge permit condition, prohibition or effluent limitation, or any order, compliance schedule, suspension or revocation shall be

civilly liable for a sum not to exceed twenty-five thousand dollars (\$25,000) per violation for each day in which such violation occurs.

2. Pursuant to the authority of Act. 33 U.S.C. Section 1251 et seq., any user, permittee, discharger or other person who violates any provision of this ordinance, any wastewater discharge permit condition, prohibition or effluent limitation, or any order, compliance schedule, wastewater discharge permit suspension or revocation shall be civilly liable for a sum not to exceed twenty-five thousand dollars (\$25,000) per violation for each day in which such violation occurs.
3. ~~The IRWD~~IRWD may petition the superior court to impose, assess and recover penalties or other such penalties as ~~the IRWD~~IRWD may impose, assess and recover pursuant to federal and/or state legislative authorization.
4. Notwithstanding any other provisions of law, all civil penalties imposed by the court for a violation of this ordinance shall be distributed to ~~the IRWD~~IRWD.
5. Remedies under this section are in addition to and do not supersede or limit any and all other remedies, civil or criminal, but no liability shall be recovered under this section for any violation for which liability is recovered under Section 909 D. of this ordinance.

D. Administrative Complaint

1. Pursuant to the authority of California Government Code Sections 54740.5 and 54740.6, ~~the IRWD~~IRWD may issue an administrative complaint to any user, permittee, discharger or other person who violates any provision of this ordinance, any wastewater discharge permit condition, prohibition or effluent limitation, or any administrative, suspension or revocation order or other control mechanism.
2. The administrative complaint shall be served by personal delivery or certified mail on such person and shall inform the person that a hearing shall be conducted, within sixty (60) days following service. The administrative complaint will allege the act or failure to act that constitutes the violation(s), set forth the provisions of law authorizing civil liability to be imposed and the proposed civil penalty. The matter shall be heard by the General Manager or his designee. The person to whom an administrative complaint has been issued may waive the right to a hearing, in which case a hearing shall not be conducted.
3. At the hearing, the person shall have an opportunity to respond to the allegations set forth in the administrative complaint by presenting written or oral evidence. The hearing shall be conducted in accordance with the procedures established by the General Manager and approved by ~~the IRWD~~IRWD's General Counsel.
4. After the conclusion of the hearing, the General Manager's designee shall submit a written report to the General Manager setting forth a brief statement of the facts found to be true, a determination of the issues presented, conclusions and a recommendation. Upon receipt of the written report, the General Manager shall make his determination and should he find that grounds exist for assessment of a

civil penalty, he shall issue his decision and order in writing within thirty (30) calendar days after the conclusion of the hearing. If not appealed, the order shall be final thirty-one (31) days after it is served on the person.

5. A person dissatisfied with the decision of the General Manager may appeal to the Board pursuant to Section 9.13 of this ordinance within thirty (30) days of notice of the General Manager's decision.
6. If, after the hearing or appeal, if any, it is found that the person has violated reporting or discharge requirements or other provisions of the this ordinance, the General Manager or Board may assess a civil penalty against that person.
7. In the determination of the amount of the civil penalty, all relevant circumstances may be taken into consideration, including, but not limited to, the extent of harm caused by the violation, the economic benefit derived through any non-compliance, the nature and persistence of the violations, the length of time over which the violation occurs and the corrective action(s), if any, attempted or taken by the person.
8. Civil penalties may be assessed as follows:
  - a. In an amount which shall not exceed two thousand dollars (\$2,000) for each day for failing or refusing to furnish technical or monitoring reports.
  - b. In an amount which shall not exceed three thousand (\$3,000) for each day for failing or refusing to timely comply with any compliance schedule
  - c. In an amount which shall not exceed five thousand dollars (\$5,000) per violation for each day for discharges in violation of any waste discharge limitation, wastewater discharge permit condition, other control mechanism or requirement issued, reissued or adopted by ~~the~~ IRWD/IRWD.
  - d. In an amount which does not exceed ten dollars (\$10) per gallon for discharges in violation of any suspensions, cease and desist order or other orders, or prohibition issued, reissued or adopted by ~~the~~ IRWD/IRWD.
9. Payment of civil penalties shall be due within thirty (30) days of the date of the order assessing the penalties becomes final. The amount of any administrative civil penalties imposed which have remained delinquent for a period of sixty (60) days from the date they are due shall constitute a lien against the real property of the discharger from which the discharge resulting in the imposition of the penalty originated. The lien shall have no force and effect until recorded with the county recorder and when recorded shall have the force and effect and priority of a judgment lien and continue for ten (10) years and be renewable in accordance with law.
10. Copies of the administrative order shall be served by personal service or by registered mail upon the party served with the administrative complaint and upon other persons who appeared at the hearing and requested a copy of the order.

11. Any party aggrieved by a final order issued by the Board after granting review of the order of the General Manager may obtain review of the order of the Board in the Superior Court, by filing in the court a petition for writ or mandate within thirty (30) days following the service of a copy of the decision and order issued by the Board.
12. Any party aggrieved by a final order issued by the General Manager, for which the Board denies review, may obtain review of the order of the General Manager in the Superior Court, by filing in the court a petition for writ of mandate within thirty (30) days following service of a copy of a decision and order denying review by the Board.
13. No administrative civil penalties shall be recoverable under this section for any violation for which civil liability is recovered under Section 9.09.C. of this ordinance.

#### **9.10 CRIMINAL PENALTIES**

- A. Any person who violates any provision of this ordinance is guilty of a misdemeanor, which upon conviction is punishable by a fine not to exceed one thousand dollars (\$1,000) or imprisonment for not more than thirty (30) days or both.
- B. Each violation shall constitute a new and separate violation and shall be subject to the penalties contained herein.

#### **9.11 PUBLIC NUISANCE**

- A. Discharge of wastewater in a manner that is in noncompliance or violation of this ordinance or of any order issued by ~~the IRWD~~IRWD, in accordance with this ordinance, shall hereby be declared a public nuisance and shall be corrected or abated as directed by ~~the IRWD~~IRWD.
- B. Any person creating a public nuisance is guilty of a misdemeanor and is subject to the criminal penalties identified in Section 9.10 of this ordinance.

#### **9.12 APPEALS TO THE GENERAL MANAGER**

- A. General
  1. Any user affected by a decision, action or determination made by IRWD staff may file with the General Manager a written request for an appeal hearing.
  2. Request must be made within fifteen (15) days of the mailing of the original decision.
  3. Request for hearing shall set forth details of all facts supporting the appellant's request for hearing.
- B. Notice

1. The General Manager shall, within fifteen (15) days of receiving the request for appeal provide written notice to the user of the hearing date, time, and place.
2. The hearing time shall not be more than thirty (30) days from the mailing of such notice by certified mail to the appellant unless a later date is agreed to by the appellant.
3. If the hearing is not held within the time set due to actions of the appellant, then ~~the IRWD~~IRWD's decision shall be deemed final.

C. Hearing

1. The appellate shall have the opportunity to present information supporting its position concerning ~~the IRWD~~IRWD's original decision, action or determination.
2. The hearing shall be conducted in accordance with procedures established by the General Manager and approved by ~~the IRWD~~IRWD's General Counsel.

D. Written Determination

1. After the hearing the General Manager shall make a determination whether to uphold, modify or reverse original decision, action or determination as issued by IRWD staff.
2. This decision shall be put into writing within a brief statement of facts found to be true, the determination of the issues presented, and the findings.
3. The final determination of the General Manager upon his approval shall be executed as the order.
4. A copy shall be mailed or delivered to the appellant.
5. The order of the General Manager shall be final in all respects fifteen (15) days after it is mailed to the appellant, unless appealed under Section 9.13 of this ordinance.

E. Wastewater Discharge Permit Suspension/Revocation Appeals

1. Appeals regarding wastewater discharge permit suspension or revocation are covered under Section 9.05 and Section 9.13 as specified in this ordinance.

**9.13 9.13 APPEALS TO THE BOARD**

A. General

1. The user may, within thirty (30) days after the date of notification of the General Manager's order upholding ~~the IRWD~~IRWD's determination, file a written appeal to the Board.
2. A fee of one hundred dollars (\$100) shall accompany the written appeal which shall be refunded if the Board of Directors reverses or modifies the order of the General Manager.

3. A request for appeal to the Board shall set forth details of the past record and that new arguments cannot be raised on appeal to the Board that could have been, but were not, raised in the prior appeal to the General Manager.
4. Pending the hearing on appeal, the user shall not be entitled to discharge into sewerage facilities beyond the effective date of the original order determined by the General Manager, unless it has been determined by the General Manager that the user is pursuing good faith arguments and approves such discharge.

B. Notice

1. The Board Secretary, within fifteen (15) days of receiving the request for appeal, will provide written notice to the user of the hearing date, time and place.
2. The hearing date shall not be more than forty-five (45) days from the mailing of such notice by certified mail to the appellate unless a later date is agreed to by the appellant.
3. If the hearing is not held within the time set due to action of the appellant, the General Manager's decision shall be deemed final.

C. Hearing

1. The appellant shall have the opportunity to present information supporting its position concerning the General Manager's determination.
2. The hearing shall be conducted in accordance with procedures established by the Board and approved by ~~the~~ IRWD's General Counsel.

D. Written Determination

1. After the hearing, the Board shall make a determination whether to uphold, modify or reverse the original decision, action or determination as ordered by the General Manager.
2. The decision of the Board shall be reduced to writing within thirty (30) days after the hearing.
3. It shall contain a brief statement of facts found to be true, the determination of the issues presented, and the findings. The decision shall be submitted to the appellant.
4. The order of the Board shall be final upon its adoption.

**9.14 9.14 JUDICIAL REVIEW**

A. Purpose and Effect

1. Pursuant to Section 1094.6 of the California Code of Civil Procedure, the time in which a user may bring an administrative mandamus action shall be limited to ninety (90) days following the final decision in the adjudicative administrative hearing in question.



B. Time Limit for Judicial Review

1. Judicial review of any decision of ~~the~~ IRWD's Board may be made pursuant to Section 1094.5 of the California Code of Civil Procedure only if the petition for writ of mandate is filed no later than ninety (90) days following the date on which any decision becomes final.

C. Preparation of Records

1. The complete record of the proceedings shall be prepared by ~~the~~ IRWD and shall be delivered or mailed to the petitioner within one hundred-ninety (190) days after ~~they have~~petitioner has filed a written request.
2. ~~The IRWD shall recover from the p~~Petitioner shall pay IRWD for IRWD's its actual costs for preparing and transcribing the record.

D. Extension

1. If the petitioner files a request for the record within ten (10) days after the date the decision becomes final, the time within which a petition may be filed, pursuant to Section 1094.5 of the California Code of Civil Procedures, shall be extended to no later than thirty (30) days following the date on which the record is delivered or mailed, by ~~the IRWD~~IRWD, to the petitioner or the petitioner's attorney of record, if appropriate.

E. Notice

1. In making a final decision, ~~the IRWD~~IRWD shall provide notice to the user whose wastewater discharge permit has been denied, suspended or revoked, that the time in which judicial review must be sought is governed by Section 1094.6 of the California Code of Civil Procedures.

F. This section does not apply to action taken under Section 9.09 of this ordinance.

**9.15 PAYMENT AND COLLECTION OF FEES AND CHARGES**

- A. Except as otherwise provided, all fees and charges are due and payable upon receipt of an invoice or notice thereof. All such amounts are delinquent if unpaid forty-five (45) days after date of invoice or notice.
- B. Any invoice or notice that becomes delinquent may have added to it an assessment in accordance with the following:
  1. Forty-six (46) days after the date of invoice or notice, an assessment of ten percent (10%) of the base amount, not to exceed a maximum of \$1,000.
  2. Ninety (90) days after the date of invoice or notice, a total of twenty-five percent (25%) of the base amount, not to exceed a maximum of \$2,500.



- C. Any invoice or notice that is outstanding and unpaid after ninety (90) days may be cause for immediate initiation of wastewater discharge permit revocation proceedings or immediate wastewater discharge permit suspension.
- D. Delinquent assessments under this section may not accrue to those invoices or notices successfully appealed, provided ~~the IRWD~~IRWD received written notice of appeal prior to the payment due date.
- E. Payment of disputed fees and charges are still required by the due date during review of any appeal submitted by permittee.
- F. This section does not apply to Section 9.09 of this ordinance.

**9.16 ~~9.16~~ RECOVERY OF ENFORCEMENT COSTS**

In the event a user fails to comply with any of the terms and conditions of this ordinance, wastewater discharge permit, administrative order, wastewater discharge permit suspension or revocation, other control mechanism or any other enforcement action, ~~the IRWD~~IRWD shall be entitled to reasonable attorney's fees and costs which may be incurred during enforcement of any terms and conditions with or without filing proceedings in court.

**9.17 FINANCIAL SECURITY CONDITIONS**

- A. Compliance Deposit
  - 1. Users that have been subject to enforcement actions and/or fees, charges, penalties or fines may be required to deposit with ~~the~~IRWD an amount determined by the General Manager as necessary to guarantee payment of all charges, fees, costs and expenses that may be incurred in the future.
  - 2. A compliance deposit shall be received by ~~the~~IRWD before ~~the~~IRWD either issues a wastewater discharge permit, other control mechanism or grants the user permission for further discharge to sewerage facilities.
- B. Delinquent Accounts
  - 1. Any user who fails to make payment in full of all fees, charges, penalties or fines assessed by ~~the~~IRWD including reconciliation amounts, delinquency fees, and other costs or fees may be required to obtain the issuance of an amendment to their wastewater discharge permit.
- C. Bankruptcy
  - 1. Any user filing any legal action in any court of competent jurisdiction, including the United States Bankruptcy Court, for purposes of discharging its financial debts or obligations or seeking court-ordered protection from its creditors, shall within ten (10) days of filing such action, apply for and obtain the issuance of an amendment to its wastewater discharge permit by ~~the~~IRWD.
- D. Wastewater Discharge Permit Amendments

1. An amendment issued to the user's wastewater discharge permit shall be in accordance with the provision of this ordinance.

E. Security Deposit

1. An amendment to a wastewater discharge permit issued in accordance with this ordinance may be conditional upon the permitted user depositing financial security in an amount equal to the total fees and charges from the preceding year.
2. Such a deposit shall be used to guarantee payment of all fees and charges incurred for future services and sewerage facilities provided by ~~the~~ IRWD and shall not be used by ~~the~~ IRWD to recover outstanding fees and charges incurred prior to the user filing and receiving protection from creditors in the United States Bankruptcy Court.

F. Return of Security Deposit

1. If the user makes full payment in time of all fees and charges incurred over a period of two (2) years following the issuance of an amendment to the user's wastewater discharge permit prescribed by this ordinance, the user's security deposit shall be returned or credited to the user's account.

**9.18 REPORT OF ANALYSIS**

All collected data from inspection and monitoring sampling conducted by ~~the~~ IRWD may be reported to the user. This data, if given to the user, shall be kept by the user and ~~the~~ IRWD and made available during inspections by ~~the~~ IRWD or any other regulatory agency.

**9.19 DAMAGE TO FACILITIES OR INTERRUPTION OF NORMAL OPERATIONS**

- A. When a discharger of wastes causes an obstruction, interference, damage, or other impairment to sewerage facilities or to the operation of sewerage facilities, ~~the~~ IRWD may assess the costs against the user for the work required to clean, replace or repair the sewerage facility together with expenses incurred to resume normal operations. This shall also be grounds for wastewater discharge permit revocation. A service charge of twenty-five percent (25%) of costs shall be added to the costs and charges to cover ~~the~~ IRWD's overhead, including administrative personnel and record keeping. The total amount shall be payable within forty-five (45) days of invoicing by ~~the~~ IRWD.
- B. If it can be shown that the discharge ~~of by~~ any user is the cause of ~~the~~ IRWD violating its NPDES permit and pretreatment requirements established by any Regulatory Agency or incurring additional expenses or suffering losses or damage to IRWD sewerage facilities, then that user shall be responsible for any costs, expenses, or assessments incurred by ~~the~~ IRWD, made by other agencies or a court.
- C. Where two or more dischargers cause a single and indivisible harm to sewerage facilities, each is jointly and severally liable for the damages. The burden of proof is on the dischargers to demonstrate that the harm is divisible.

**9.20 INDUSTRIAL WASTE PASS THROUGH**

- A. If an industrial waste discharge results in a "pass through" event in sewerage facilities, all costs associated with the event, including but not limited to treatment costs, fines, regulatory fines, and other indirect costs may be charged against the user.
- B. The user shall submit plans which prevent future recurrences to the satisfaction of ~~the~~ IRWD.
- C. A second occurrence shall be grounds for wastewater discharge permit revocation without the right of appeal.

**9.21 BATCH DUMPS**

- A. When ~~the~~ IRWD determines that a user has discharged concentrated noncompatible wastes into a sewerage facility in a manner or method that is not approved by ~~the~~ IRWD, any enforcement action may be taken as set forth in this ordinance.
- B. The user shall be subject to wastewater discharge permit suspension or revocation in accordance with this ordinance as well as any other legal enforcement penalties or remedies available to ~~the~~ IRWD.

**9.22 PUBLICATION OF USERS IN SIGNIFICANT NONCOMPLIANCE (SNC)**

- A. To comply with the requirements of 40 CFR 403, ~~the IRWD~~IRWD shall annually publish the names of all industrial users that are in SNC (per Section 202 of this ordinance) of federal pretreatment standards.
- ~~B.~~ Publication of this SNC notice shall be in the newspaper of general circulation that provides meaningful public notice within the IRWD service area tributary to SOCWAs.
- ~~C.B.~~ The determination of SNC is based upon the definition set forth in Section 202 B.88. of this ordinance.

**ARTICLE 10  
FEES AND CHARGES**

**10.01 APPLICATION FEE**

- A. All application fees shall be in an amount as established by ~~the~~ IRWD.
- B. Payment of the application fee must be received before the issuance of a new or renewal of a wastewater discharge permit.
- C. User shall pay any delinquent invoices in full, prior to the wastewater discharge permit renewal.

**10.02 ANNUAL WASTEWATER DISCHARGE PERMIT FEE**

- A. The annual wastewater discharge permit fee shall be in an amount as established by ~~the~~ IRWD.
- B. The annual wastewater discharge permit fee shall be due on or before the date set by ~~the~~ IRWD.

**10.03 INSPECTION, MONITORING AND SAMPLING CHARGES**

Any and all costs incurred by ~~the~~ IRWD to inspect, monitor and sample a user for the purpose of assuring compliance with this ordinance, the user's wastewater discharge permit, other control mechanism or other regulations shall be paid for by the user only upon receipt of an invoice or bill from ~~the~~ IRWD or its representative.

**10.04 DELINQUENCY FEES**

- A. Any fees that become delinquent may have added to it an amount as set forth in Section 9.15 of this ordinance.
- B. Any delinquent fee and all assessments including court costs and legal fees thereon may be collected by lawsuit in the name of ~~the~~ IRWD.

**10.05 ADDITIONAL FEES AND CHARGES**

- A. The user will be required to pay all applicable additional fees and charges that are established by ~~the~~ IRWD only upon receipt of an invoice or bill.
- B. Any wastewater discharge permit issued for a location where the user is not the property owner, may be conditioned upon depositing financial security to guarantee payment of all additional fees and charges to be incurred, in accordance with the provisions of Section 9.17 of this ordinance.

**10.06 RECORDING OF FEES AND CHARGES**

- A. ~~The~~ IRWD ~~may~~ shall keep a permanent record and account of all fees and charges received under this ordinance.
- B. Record information shall include, but is not limited to:
  - 1. Name and address of user.
  - 2. Date and amount of fee or charge.
  - 3. Purpose for which fees or charges were paid.

**ARTICLE 11  
SEVERABILITY**

**11.01 SEVERABILITY**

- A. If any provisions of this ordinance or the application thereof to any users or circumstances is held invalid, unenforceable, or unconstitutional by any court of competent jurisdiction, the remainder of this ordinance or the application of such provision to other users or other circumstances shall not be affected.
- B. If any section, subsection, clause or phrase of this ordinance is for any reason held to be invalid, unenforceable or unconstitutional by any court of competent jurisdiction, such decision shall not affect the remaining portions of this ordinance. The Board declares that it would have passed said ordinance by section, subsection, sentence, clause or phrase thereof.

**ARTICLE 12  
REPEAL**

**12.01 REPEAL**

- A. Ordinance No. ~~2011-XX~~2015-01 is hereby repealed in its entirety.
- B. All ordinances or parts of ordinances inconsistent with this ordinance are hereby repealed to the extent that they are inconsistent with the provisions of this ordinance.

**ARTICLE 13  
EFFECTIVE DATE**

**13.01 EFFECTIVE DATE**

This ordinance ~~shall~~becomes effective thirty (30) days after adoption. The Secretary of IRWD is directed to certify to the adoption of this ordinance and to cause a summary hereof to be published in a newspaper of general circulation as required by law.

~~A. B. ——— Amendments to this ordinance shall become effective thirty (30) days after their adoption.~~

PASSED AND ADOPTED by the Board of Directors of the Irvine Ranch Water District on  
~~\_\_\_\_\_~~, 2020. ~~this \_\_\_\_\_ day of~~  
~~\_\_\_\_\_, 2015~~

**IRVINE RANCH WATER DISTRICT**

Dated \_\_\_\_\_ by \_\_\_\_\_

**President**

Dated \_\_\_\_\_ by \_\_\_\_\_

**Secretary**

Note: This page is intentionally left blank.

## EXHIBIT “B”

### SUMMARY OF REVISIONS TO IRVINE RANCH WATER DISTRICT WASTE DISCHARGE PRETREATMENT AND SOURCE CONTROL PROGRAM, AS SET FORTH IN AN ORDINANCE OF REGULATIONS FOR THE DISCHARGE OF WASTEWATER TO SEWERAGE FACILITIES OF THE IRVINE RANCH WATER DISTRICT THAT ARE TRIBUTARY TO THE SOUTH ORANGE COUNTY WASTEWATER AUTHORITY

- Update the numbering and Table of Contents
- Required reference to the Enforcement Response Plan. (see Section 1.02. Objectives. Line Item 11, and Article 9. Section 9.01. Item C.)
- Required edit to the term “Enforcement.”
- Required addition of definition of term “Dry Weather Nuisance Flow.”
- Required addition of definition of terms for “Indirect Discharge” and “Discharge.”
- Required modification of definition of terms for “National Pretreatment Standards” and “Slug Discharge.”
- Addition of definition of term for “Non-Stormwater Discharge.” Modification of definition of term for “Stormwater.”
- Add clarifying language to Article 3 Section 3.01 Authority.
- Replace outdated reference with new name for state agency in Article 5 Section 5.12 Limitations on Radioactive Wastes.
- Required modification of language in Article 8. Section 8.02. Self-Monitoring and Reporting. Line Item H. – to make more consistent with Federal Regulations. Also correct a typographical error in this paragraph changing the initials “MNWD” to “IRWD.”



Note: This page is intentionally left blank.

October 26, 2020

Prepared by: R. Burk / M. Cortez

Submitted by: K. Burton

Approved by: Paul A. Cook



## ACTION CALENDAR

### MICHELSON WATER RECYCLING PLANT PRIMARY CLARIFIERS 1-5 COVERS REPLACEMENT CONSTRUCTION AWARD

#### SUMMARY:

The Michelson Water Recycling Plant (MWRP) Primary Clarifiers 1-5 Covers Replacement project will replace the aluminum covers for Primary Clarifiers 1-5, influent and effluent channels, and two junction boxes. The project will also perform structural repairs to the influent and effluent channels and Primary Sludge Pumps Gallery. Staff recommends the Board authorize the General Manager to execute a construction contract with GSE Construction Company, Inc. in the amount of \$840,300 for the MWRP Primary Clarifiers 1-5 Covers Replacement project.

#### BACKGROUND:

The existing aluminum covers on the Primary Clarifiers 1 through 5 at MWRP were installed in 1996. In July 2018, one of the covers for Primary Clarifier 5 failed, causing an unsafe work environment. A fall arrest system was subsequently installed at Primary Clarifiers 1 through 5 to protect staff, and in October 2019, Carollo Engineers performed an onsite condition assessment of the covers and recommended replacement of the covers within 18 months.

This project is for the replacement of the existing aluminum covers for Primary Clarifiers 1-5, the influent and effluent channels, and two junction boxes. IRWD retained Carollo to provide engineering design services for the replacement of the covers. The replacement covers for Primary Clarifiers 1-5 will be similar to the covers installed on the MWRP Phase II Primary Clarifiers 6 through 9 and will have hinged access hatch panels and handgrips to facilitate access. In addition, structural repairs will be made to the influent and effluent channels and the Primary Sludge Pumps Gallery.

#### Construction Bid:

The project was advertised to a select bidders list of 16 mechanical contractors on August 25, 2020. The bid opening occurred on October 13, 2020. Four bids were received from GSE Construction Company, Environmental Construction, SS Mechanical Construction, and PCL Construction.

The bids are summarized in the following table.

<b>Bidder</b>	<b>Bid Amount</b>
GSE Construction Company, Inc.	\$840,300
Environmental Construction, Inc.	\$897,484
SS Mechanical Construction Corp.	\$905,409
PCL Construction, Inc.	\$952,910
<i>Engineer's Estimate</i>	<i>\$924,000</i>

GSE was the apparent low bidder with a bid of \$840,300, and the bid results are provided as Exhibit "A". GSE was recently added to IRWD's prequalified contractor list and this will be its first project with the District. The bids ranged from nine percent lower to three percent higher than the engineer's estimate of \$924,000.

FISCAL IMPACTS:

Project 11599 is included in the FY 2020-21 Capital Budget. The existing capital budget and Expenditure Authorization are sufficient to fund the construction contract.

ENVIRONMENTAL COMPLIANCE:

This project is exempt from the California Environmental Quality Act (CEQA) as authorized under the California Code of Regulations, Title 14, Chapter 3, Section 15301 which provides exemption for minor alterations of existing public or private structures, facilities, mechanical equipment, or topographical features, involving negligible or no expansion of use beyond that existing at the time of the lead agency's determination. A Notice of Exemption for the project will be filed with the Orange County Clerk-Recorder.

COMMITTEE STATUS:

Construction awards are not routinely taken to a Committee prior to submittal to the Board.

RECOMMENDATION:

THAT THE BOARD AUTHORIZE THE GENERAL MANAGER TO EXECUTE A CONSTRUCTION CONTRACT WITH GSE CONSTRUCTION COMPANY, INC. IN THE AMOUNT OF \$840,300 FOR THE MICHELSON WATER RECYCLING PLANT PRIMARY CLARIFIERS 1-5 COVERS REPLACEMENT, PROJECT 11599.

LIST OF EXHIBITS:

Exhibit "A" – Bid Results

**Bid Results****Bidder Details**

**Vendor Name** GSE Construction Company Inc.  
**Address** 7633 Southfront Road  
 Suite 160  
 Livermore, CA 94551  
 United States  
**Respondee** Vina Ontiveros  
**Respondee Title** Contracts Manager  
**Phone** 925-344-9848 Ext.  
**Email** vontiveros@gseconstruction.com  
**Vendor Type** CADIR  
**License #** 401498  
**CADIR** 1000000077

**Bid Detail**

**Bid Format** Electronic  
**Submitted** October 13, 2020 1:43:06 PM (Pacific)  
**Delivery Method**  
**Bid Responsive**  
**Bid Status** Submitted  
**Confirmation #** 230747  
**Ranking** 0

**Respondee Comment****Buyer Comment****Attachments**

File Title	File Name	File Type
GSE Scanned Bid Documents	GSE Scanned Bid Documents.pdf	Bid Form

**Line Items**

Type	Item Code	UOM	Qty	Unit Price	Line Total	Comment
<b>BASE BID ITEMS</b>						
1	Mobilization, Demobilization, and Cleanup	LS	1	\$40,000.00	\$40,000.00	
2	Demolition of Existing Covers	LS	1	\$70,000.00	\$70,000.00	
3	Concrete Repairs to Influent and Effluent Channels and Primary Clarifiers 1-5	LF	230	\$70.00	\$16,100.00	
4	Primary Sludge Pumps Gallery Surface Cracking Repairs	LF	60	\$150.00	\$9,000.00	
5	Primary Sludge Pumps Gallery Spalling/Delaminating Repairs	LF	20	\$105.00	\$2,100.00	

**Bid Results**

Type	Item Code	UOM	Qty	Unit Price	Line Total	Comment
6	Primary Sludge Pumps Gallery Exposed Rebar Repairs	LF	10	\$320.00	\$3,200.00	
7	Primary Sludge Pumps Gallery Painting	SF	5250	\$8.00	\$42,000.00	
8	Procurement and Installation of New Covers	LS	1	\$595,900.00	\$595,900.00	
9	Ventilation Ducts Modifications	LS	1	\$60,000.00	\$60,000.00	
10	Prepare As-Built Drawings	LS	1	\$2,000.00	\$2,000.00	
					<b>Subtotal</b>	<b>\$840,300.00</b>
<b>ADDITION OR DEDUCTION LINE ITEM</b>						
11	ADDITION (+) OR DEDUCTION (-)	LS	1	0	0	
					<b>Subtotal</b>	<b>0</b>
					<b>Total</b>	<b>\$840,300.00</b>

**Subcontractors**

Name & Address	Description	License Num	CADIR	Amount	Type
<b>Murphy Industrial Coatings, Inc.</b> 2704 Gundry Ave Signal Hill, CA 90755 United States	Coatings	310594	1000005885	\$39,723.00	
<b>Hallsten Corporation</b> PO Box 41036 Sacramento, CA 95841 United States	Cover Installation	953403	1000027657	\$77,000.00	CADIR